

TPC Zinc Oxide Varistors

	Page
Introduction	3
Applications	8
Selection Guide	10
Ordering Code	11
VE / VF Types	12
Electrical Characteristics (VE / VF types)	22
VN 32	29
VB 32	30
Taping Characteristics	31
Packaging	33
Quality	34
Manufacturing Process and Quality Assurance	35
Reliability	36

As we are anxious that our customers should benefit from the latest developments in technology and standards, AVX reserves the right to modify the characteristics published in this brochure.

Zinc Oxide Varistors



General

Metal Oxide Varistors are ceramic passive components made of zinc oxide sintered together with other metal oxide additives.

They provide an excellent protective device for limiting surge voltages and absorbing energy pulses.

Their very good price / performance ratio enables designers to optimize the transient protection function when designing the circuits.

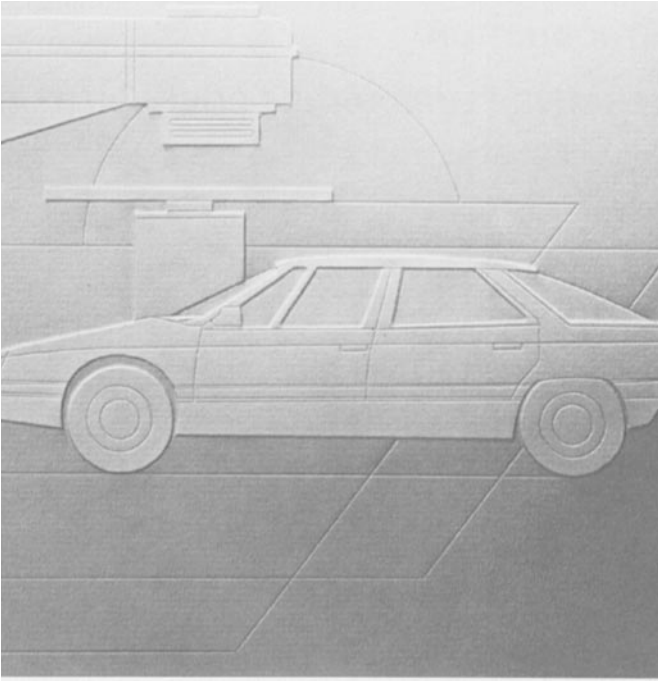

Varistors are Voltage Dependent Resistors whose resistance decreases drastically when voltage is increased. When connected in parallel with the equipment to protect, they divert the transients and avoid any further overvoltage on the equipment.

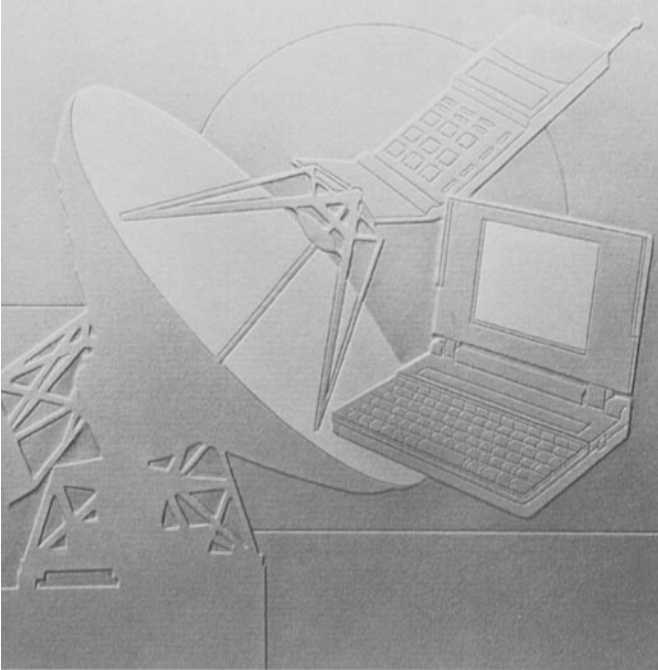

Manufactured according to high level standards of quality and service, our Metal Oxide Varistors are widely used as protective devices in the telecommunications, industrial, automotive and consumer markets.

Zinc Oxide Varistors

Introduction

ZINC OXIDE VARISTORS. PROTECTION FUNCTION APPLICATION

Definition of the varistor effect

The varistor effect is defined as being the property of any material whose electrical resistance changes non-linearly with the voltage applied to its terminals.

In other words, within a given current range, the current-voltage relationship can be expressed by the equation:

$$I = KV^\alpha$$

In which K represents a constant depending on the geometry of the part and the technology used and α the non-linearity factor.

The higher the value of this factor, the greater the effect. The ideal (and theoretical) case is shown in Figure 1 where $\alpha = \infty$ whereas a linear material has an equation of $I = f(V)$ obeying the well-known Ohm's law ($\alpha = 1$).

The relationship between these two extreme cases is shown in Figure 2. It should be pointed out that the $I = f(V)$ curve is symmetrical with respect to zero in the case of zinc oxide varistors.

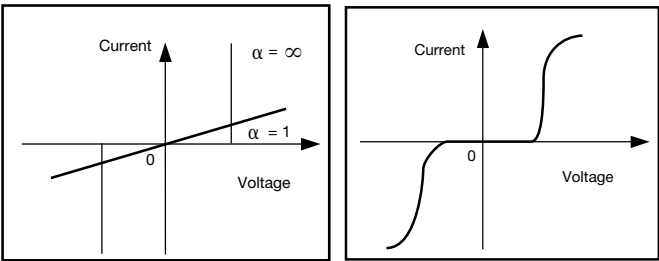

Figure 1

Figure 2

ZINC OXIDE VARISTORS

1-Composition of the material

Zinc oxide varistors are a polycrystalline structured material consisting of semiconducting zinc oxide crystals and a second phase located at the boundaries of the crystals.

This second phase consists of a certain number of metallic oxides ($\text{Bi}_2\text{O}_3, \text{MnO}, \text{Sb}_2\text{O}_3$, etc.). It forms the «heart» of the varistor effect since its electrical resistivity is a non-linear function of the applied voltage.

Thus, a zinc oxide varistor consists of a large number of boundaries (several millions) forming a series-parallel network of resistors and capacitors, appearing somewhat like a multijunction semiconductor.

Experimentally, it is found that the voltage drop (at 1mA) at each boundary is about 3V. The total voltage drop for the thickness of the material is proportional to the number N of boundaries.

$$V_{1mA} \approx 3N \text{ where } N = \frac{t}{L}$$

in which L represents the average dimension of a zinc oxide grain and t the thickness of the material.

$$\text{In other words: } V_{1mA} \approx 3 \frac{t}{L}$$

Thus, with a thickness of 1 mm and average dimension of $L = 20 \mu$, we obtain a voltage of 150 V for a current of 1mA.

The desired voltage at 1mA can thus be obtained either by changing the thickness of the disc or by controlling the average dimension of the zinc oxide grain through heat treatment

or, yet again, by changing the chemical composition of the varistor.

The polycrystal is schematically represented in Figure 3. At room temperature the semiconducting grains have very low resistivity (a few ohms/cm).

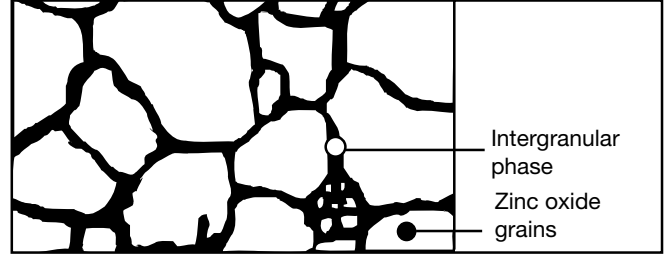

Figure 3

On the contrary, the resistivity of the second phase (or intergranular layer) basically depends on the value of the applied voltage.

If the voltage value is low, the phase is insulating (region I of the $I = f(V)$ curve). As the voltage increases this phase becomes conductive (region II). At very high current values the resistivity of the grain can become preponderant and the $I = f(V)$ curve tends towards a linear law (region III).

The curve $I = f(V)$ for the different types can be found in corresponding data sheets.

2 - Equivalent electrical circuit diagram

Figure 4 explains the behavior of a zinc oxide varistor. r represents the equivalent resistance of all semiconducting grains and ρ that of the intergranular layer (the value of which basically varies with the applied voltage). Cp corresponds to the equivalent capacitance of the intergranular layers.

When the applied voltage is low, the resistivity of the intergranular layer is quite high and the current passing through the ceramic is low. When the voltage increases, the resistance ρ decreases (region II in Figure 5).

When a certain voltage value is reached, ρ becomes lower than r and the $I = f(V)$ characteristic tends to become ohmic (region III).

The equivalent capacitance due to the insulating layers depends on their chemical types and geometries.

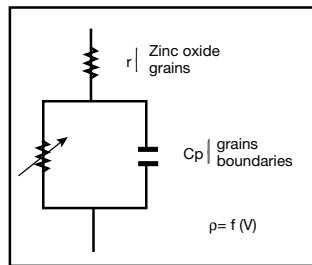

Figure 4

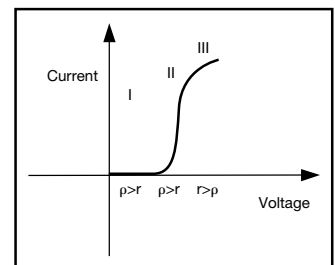

Figure 5

Values of a few hundred picofarads are usually found with commonly used discs.

Capacitance value decreases with the area of the ceramic. Consequently, this value is lower when maximum permissible energy and current values in the varistor are low, since these latter parameters are related to the diameter of the disc.

Capacitance values are not subject to outgoing inspection.

Introduction

3 - Temperature influence on the $I = f(V)$ characteristic

A typical $I = f(V)$ curve is given in Figure 6.

Different distinct regions can be observed:

- The first one depends on the temperature and corresponds to low applied voltages (corresponding currents are in the range of the μA). Consequently, a higher leakage current is noticeable when temperature is increasing.
- The second one shows less variation and corresponds to the nominal varistor voltage region (Figure 7). The temperature coefficient of the varistor voltage at 1 mA is:

$$K = \frac{\Delta V/V}{\Delta T} \text{ and has a negative value with } |K| < 9.10^{-4}/^{\circ}C$$

As the temperature coefficient decreases with increasing current density, this curve also depends on the type of the varistor.

- For higher voltages, the temperature has no significant influence. Practically the clamping voltages of the varistors are not affected by a temperature change.

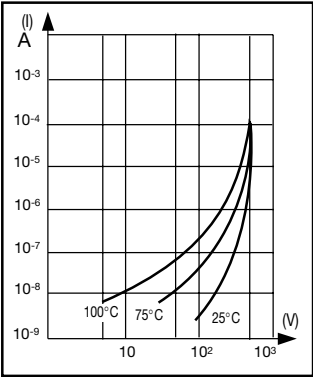

Figure 6

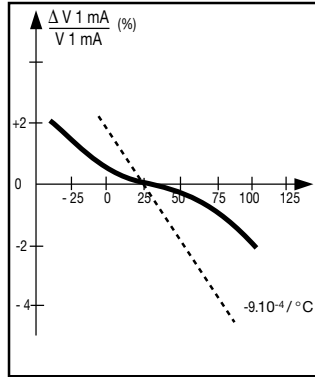

Figure 7

4 - Varistor characteristics

The choice of a varistor for a specific application should be guided by the following major characteristics:

- 1) Working or operating voltage (alternating or direct).
- 2) Leakage current at the working voltage.
- 3) Max. clamping voltage for a given current.
- 4) Maximum current passing through the varistor.
- 5) Energy of the pulse to be dissipated in the varistor.
- 6) Average power to be dissipated.

4.1 - Max. operating voltage and leakage current

The maximum operating voltage corresponds to the "rest" state of the varistor. This "rest" voltage offers a low leakage current in order to limit the power consumption of the protective device and not to disturb the circuit to be protected. The leakage currents usually have values in the range of a few micro-amperes.

$$P_A = AV \cdot I_p = AKVp^{\alpha+1}$$

$$\text{with } \frac{P_A}{P_C} = A$$

in which: A = a constant $f(\alpha)$

K = a constant

$$(I = KV^{\alpha}).$$

P_C = dissipated power for a DC voltage V_p .

The A versus α curve

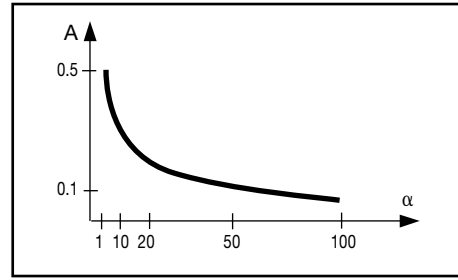

Figure 8

For usual values of α (30 to 40), the continuously dissipated power is about 7 times greater than that dissipated by a sinusoidal signal having the same peak value. For example, a protective varistor operating at RMS voltage of 250 V has a power dissipation of a few mW.

4.2 - Non-linearity coefficient

The peak current and voltage values basically depend on the $I = f(V)$ characteristic or, to be more precise, on the value of the coefficient defined by:

$$\alpha = \frac{\log(I_1/I_2)}{\log(V_1/V_2)}$$

In which I_1 and I_2 are the current values corresponding to voltage values V_1 and V_2 .

The value of α depends on the technology used (chemical composition, heat synthesis, etc.). Nevertheless, the value is not constant over the entire current range (several decades). For example, Figure 9 shows the variation of this coefficient for currents ranging from 100 nA to 100 A. It can be seen that α passes through a maximum value and always stays at high values, even at high levels of current.

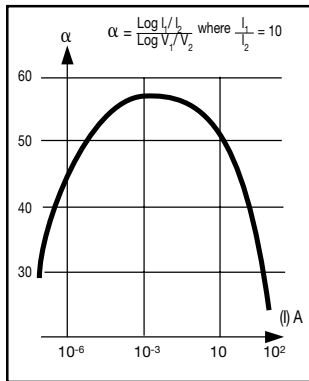

Figure 9

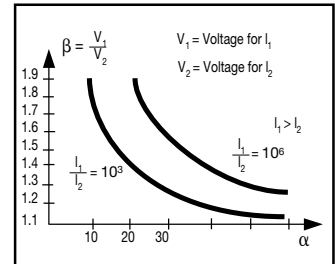

Figure 10

The non-linearity of the varistor can be expressed in another way by the ratio of the voltages corresponding to 2 current values.

$$\beta = \frac{V_1}{V_2}$$

Where:

V_1 voltage for current I_1

V_2 voltage for current I_2

The curve giving β versus the value of α is shown in Figure 10 for 2 ratios of $I_1/I_2 = 10^3$ and 10^6 .

Zinc Oxide Varistors

Introduction

4.3 - Clamping voltage

It is the maximum residual voltage V_p across the varistor terminals for a through current I_p .

The voltage value gives an indication on the protective function of the varistor.

4.4 - Permissible peak current

The value of the permissible peak current depends upon the varistor model and waveform ($8 \times 20 \mu s$, $10 \times 1000 \mu s$, etc.).

It can be seen that, as a first approximation, the permissible peak current is proportional to the area of the varistor electrodes.

By way of example, Table I gives the permissible peak current values for different diameters and for one current surge of waveform $8 \times 20 \mu s$.

It corresponds to a maximum permissible variation of $\pm 10\%$ in the voltage measured at 1 mA dc after the surges.

Overloads greater than specified values may result in a change in varistor voltage by more than $\pm 10\%$ and irreversible change in the electrical properties.

In case of heavy overload, surge currents beyond the specified ratings will puncture the varistor element. In extreme cases, the varistor will burst.

Operating Voltage (V)	Uncoated Disc \varnothing (mm)	I max. (A)
250	5	400
250	7	1200
250	10	2500
250	14	4500
250	20	6500

Table I

Permissible Current (A)	Number of Current Surges ($8 \times 20 \mu s$)
6500	1
4000	2
1000	10^2
200	10^4

Table II

The permissible peak current also depends on the number of current surges applied to the varistor. For example, Table II gives the permissible current values based on the number of consecutive surges of the same magnitude applied on varistor model VE24M00251K.

Thus, the smaller the number of surges, the higher the permissible current.

4.5 - Permissible energy

The notion of permissible energy relates much more to the "active" state of the varistor than to its "rest" state where the average power is the predominant notion.

Indeed, except in special cases, the overvoltages occur at random and not at a high repetition frequency.

Therefore, aging of the varistor will be related to energy of the transient defined by the current and peak voltage values as well as the pulse shape.

Opposite, we have expressed energy W calculated for different pulse shapes, assuming that the value of the coefficient α equals 30.

a) Voltage surge
Figure 11 - 12 - 13 - 14

b) Current surge
Figure 15 - 16 - 17 - 18

If, for example, we take a current surge as shown in Figure 19, we demonstrate that the dissipated energy is given by the approximate expression:

$$W = V_p I_p (1.4 \tau_2 - 0.88 \tau_1) 10^{-6}$$

in which V_p is the peak voltage value and I_p the peak current value.

W is expressed in joules.

τ in μ seconds.

V_p in volts.

I_p in amperes.

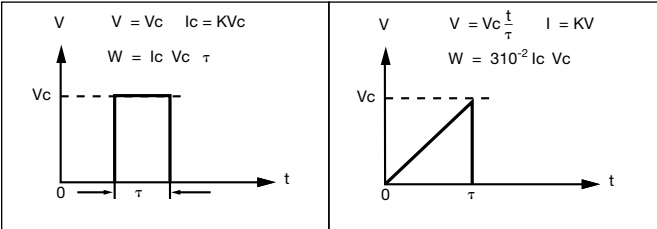

Figure 11

Figure 12

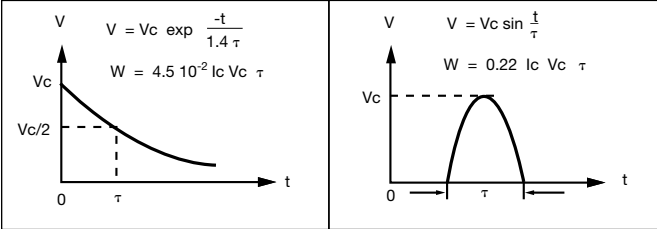

Figure 13

Figure 14

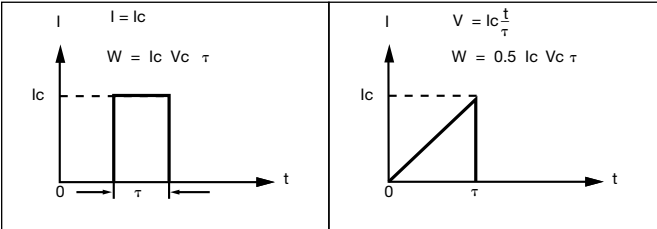

Figure 15

Figure 16

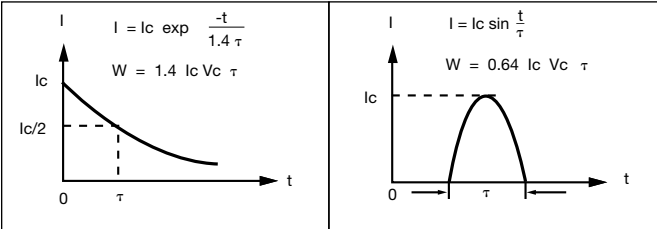

Figure 17

Figure 18

Introduction

Table III gives the energies calculated according to waveform in Figure 19.

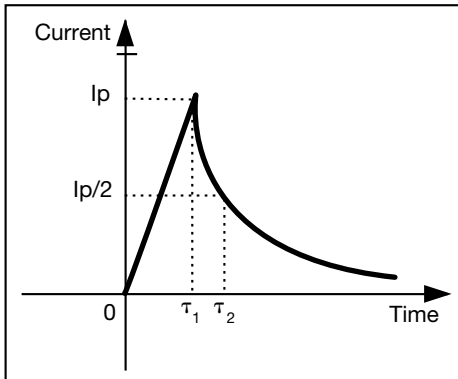

Figure 19

Table III

Vp (V)	Ip (A)	Waveform (µs)		Energy (J)
		τ ₁	τ ₂	
500	300	1.2	50	10
500	300	8	20	3
500	300	10	1000	210

The following changes are found when the varistor absorbs an energy greater than the maximum permissible value:

- Higher leakage current.
- Decrease in the voltage at 1 mA.
- Decrease in coefficient α .

If the energy increases well beyond the maximum value, the characteristics degrade to such an extent that, even at the rated voltage, the varistor has a very low resistance value.

The permissible energy for a given varistor is mainly related to the size of the part. For example, Table IV gives the permissible energy for different varistors sizes with an operating voltage of 250 V.

Table IV

Operating Voltage (V)	Uncoated Disc ø (mm)	Energy (J)
250	5	10
250	7	21
250	10	40
250	14	72
250	20	130

Table V

V- (V)	P (mW)
180	0.5
220	0.2
230	0.75

4.6 - Average dissipated power

a) Average power dissipated in the “rest” state

Considering the high values of the coefficient α , a special attention is required concerning the dissipated power value in case of possible changes in the operating voltage.

Indeed, starting with the equation:

$$I = KV^\alpha$$

the average power dissipated by the varistor is given by the equation:

$$PC = KV^{\alpha+1}$$

when a direct current voltage is applied, and

$$P_A = AP_C$$

in the case of a sinusoidal voltage having the same peak value and direct current voltage value.

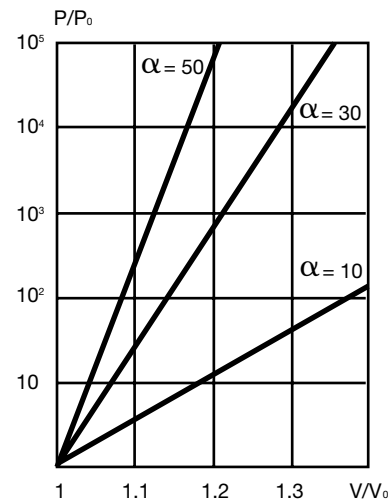

Figure 20

The A value as a function of α was given in Figure 8. A small change of the operating voltage can induce a dissipated power variation which is all the more greater since the value of exponent α is high (Figure 20).

It can be seen that a 10% change in the rated voltage increases the dissipated power by a factor of 20 when coefficient α equals 30, and by a factor of 150 when the coefficient equals 50.

Table V gives the power P dissipated at values of the applied direct current voltage when the value of α equals 30.

b) Average power dissipated during the transient state

If the transients to which the varistor is subjected are repeated at a sufficiently high frequency, there will be an increase ΔT in the average temperature of the part given by the expression:

$$\Delta T = P/\delta$$

in which P represents the average dissipated power which depends on the energy of the pulse and its repetition frequency and δ the dissipation factor in air of the unit.

This temperature rise should stay below the threshold indicated by the manufacturer or it may damage the component coating resin or even cause thermal runaway of the ceramic.

Zinc Oxide Varistors

Introduction

5 - Response time of zinc oxide varistors

5.1 - Intrinsic response time

This response time corresponds to the conduction mechanisms specific to semiconductors, therefore its value is quite low and is less than one nanosecond.

5.2 - Practical response time

However, the response time will be modified for several reasons:

- Parasitic capacitance of the component due to the insulation of the intergranular layers.
- Overshoot phenomenon occurring when the varistor is subjected to a voltage with a steep leading edge (Figure 21) and causing a dynamic voltage peak greater than the static voltage by a few percent.
- Impedance of the external circuit to the varistor.

In conclusion, the practical response time of a zinc oxide varistor usually stays below 50 nanoseconds.

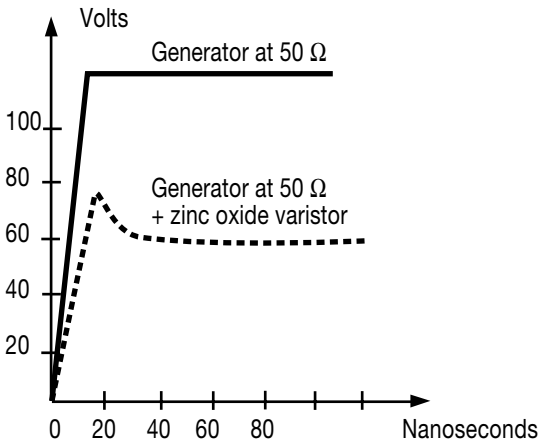

Figure 21

6 - Varistor voltage (V_{1mA})

6.1 - Nominal varistor voltage (V_{1mA})

The nominal voltage of a varistor (or “varistor” voltage) is defined as the voltage drop across the varistor when a dc test current of 1 mA is applied to the component.

It is defined at a temperature of 25°C.

This parameter is used as a standard to define the varistors but has no particular electrical or physical significance.

6.2 - Tolerance on the varistor voltage

The standard tolerance is $\pm 10\%$. Other tolerances may be defined on custom design products.

To avoid any lack of understanding, different behaviors of ZnO varistors should be noted when considering the measurement of V_{1mA} .

- The measurement time must not be too short to allow a “break-in” stabilization of the varistor and not too long so the measurement is not affected by warming the varistor. The limits of V_{1mA} for our products are given for a measurement time comprised between 100 ms and 300 ms. For times comprised between 30 ms and 1s, the varistor voltage will differ typically by less than 2%.
- The value of the peak varistor voltage measured with ac current will be slightly higher than the dc value.
- When the varistor has been submitted to unipolar stresses (pulses, dc life test, ...) the voltage-current characteristic becomes asymmetrical in polarity.

Zinc Oxide Varistors

Applications

1 - Principle of application

Zinc oxide varistors are essentially used as protective devices for components or items of equipment subjected to electrical interference whether accidental or otherwise. To be more specific, there are two types of interference: those which can be controlled (switching of resistive or capacitive circuits) and those which occur at random (high voltage surges change in the power supply network, etc.)

The “protection” function is related to the non-linear $I = f(V)$ characteristic of the varistor. This component is always connected in parallel with the assembly E to be protected (Figure 22B).

The varistor’s “rest” state has a very high impedance (several megohms) in relation to the component to be protected and does not change the characteristics or the electric circuit.

In the presence of a transient, the varistor then has a very low impedance (a few ohms) and short circuits the component E.

The “rest” and operating states are shown in Figure 22A and 22B. In case of a current surge of a peak value I_p , the higher the non-linear coefficient α is, the lower the voltage across the terminals of the component E will be:

$$V_p = (I_p/K) 1/\alpha$$

In case of a voltage surge V_s , the varistor limits the voltage across the terminals of component E to a value V_p via resistor R_c which can be the impedance of the source (Figure 23).

2 - Main applications

Varistors are widely used in the different electronic equipment:

- telecommunication and data systems
 - power supply units,
 - switching equipment,
 - answering sets, ...
- industrial equipment
 - control and alarm systems,
 - proximity switches,
 - transformers,
 - motors,
 - traffic lighting, ...
- consumer electronics
 - television and video sets,
 - washing machines,
 - electronic ballasts, ...
- automotive
 - all motor and electronic systems.

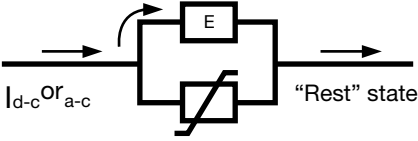

Figure 22A

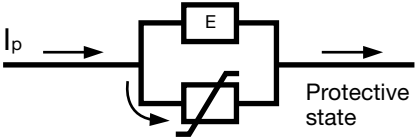

Figure 22B

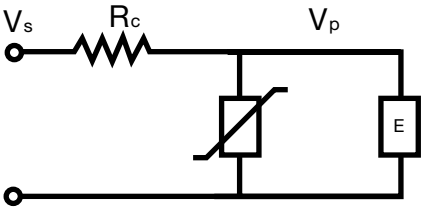

Figure 23

Applications

Three typical examples of applications are shown to illustrate the “protection” function of zinc oxide varistors.

1 - Protection of relay contacts

It is a well-known fact that a sudden break in an inductive circuit causes an overvoltage which can seriously damage the contacts of relay due to arcing. Overvoltages of several thousand volts can occur across the terminals of unprotected relay contacts. This disadvantage can be overcome by limiting the overvoltage due to opening an inductive circuit to a level such that it cannot generate an arc. Such limitation is achieved by wiring a zinc oxide varistor in parallel across the terminals of the relay characterized by the value of its inductance coil L and its resistor R (Figure 24).

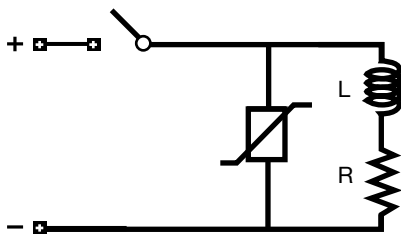

Figure 24

2 - Protection of a diode rectifier bridge

Semiconductor components (silicon diodes, thyristors, etc.) are especially sensitive to transients and must be protected so that the overvoltage value is limited to levels which are not dangerous.

An example of protection for a diode rectifier is schematically represented in Figure 25. The varistor is connected to the transformer secondary at the input of rectifier bridge.

If the transformer's magnetizing current is interrupted when it reaches its maximum value, a voltage ten times greater than the normal value can then appear at the terminals of the secondary winding in the absence of a load.

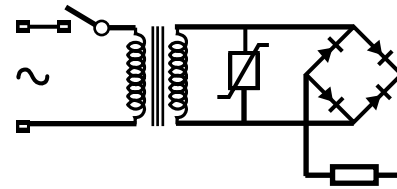

Figure 25

This overvoltage, which is excessive for the semiconductors, is limited by the presence of the varistor which absorbs the energy corresponding to the change of state of the primary circuit.

The same varistor can also protect the rectifier bridge against overvoltages coming from the mains and reaching the secondary circuit via the stray capacitance of the transformer.

Another practical case to be considered involves closing of the primary circuit. If the circuit is closed when the primary voltage reaches its maximum value, the secondary voltage can be two times greater than its steady-state value. Although this case is less dangerous than the preceding one, it still may cause damage to the rectifying diodes. Connection of a varistor in parallel limits this overvoltage to a value such that it does not cause any damage to the semiconductors.

3 - Opening of a resistive circuit supplied with AC current with a loadless rectifier

The diagram is given in Figure 26. When the circuit supplied with AC current is opened, an overvoltage appears across the rectifier terminals:

$$- L di/dt$$

The energy stored by the inductance coil ($1/2 L I^2$ rms) is transferred to the protective varistor wired in parallel to the inductance coil.

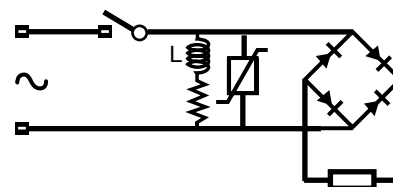

Figure 26

Zinc Oxide Varistors



Selection Guide

Maximum Operating RMS Voltage (V_{RMS})	V_{RMS}
Maximum Operating Steady State Voltage (V_{DC})	V_{DC}
Nominal Varistor Voltage (V_{1mA})	V_{1mA}
Types	Voltage range and admissible energy (J) (1 surge 10 x 1000 μs)
VE 07 VF 05 	
VE 09 VF 07 	
VE 13 VF 10 	
VE 17 VF 14 	
VE 24 VF 20 	
VN 32 	
VB 32 	

Zinc Oxide Varistors



Ordering Code

HOW TO ORDER

VE09

Type

VE 07
VE 09
VE 13
VE 17
VE 24
VF 05
VF 07
VF 10
VF 14
VF 20
VN 32
VB 32

M

Series

M: Varistors for general applications
P: Varistors for heavy duty applications

0

Marking

AC nominal voltage
VE:0

Nominal voltage at 1 mA dc
VF:1

0251

AC Operating Voltage
(EIA coding)
VE

Operating Voltage
at 1 mA dc
(EIA coding)
VF

K

Tolerance
at 1 mA
K: $\pm 10\%$
(J: $\pm 5\%$ upon request)

--

Suffixes
See on page 32

-
1. Operating voltage expressed by 2 significant figures:
1st digit: 0 (zero).
2nd and 3rd digit: the two significant figures of the operating voltage.
4th digit: the number of ZEROS to be added to the operating voltage value.

Examples: 75 V: 0750
250 V: 0251
300 V: 0301
 2. Operating voltage expressed by 3 significant figures:
1st, 2nd and 3rd digit: the 3 significant figures of the operating voltage.
4th digit: the number of ZEROS to be added to the operating voltage value.

Examples: 205 V: 2050
275 V: 2750

Zinc Oxide Varistors



VE 07/09/13/17/24

VF 05/07/10/14/20

FEATURES

- Radial lead varistors
- Wide operating voltage range from 11 V to 625 V (V_{rms} for VE types) or 18 V to 1000 V (V_{1mA} for VF types)
- Available in tape and reel for use with automatic insertion equipment (see pages 31 to 33 for details).

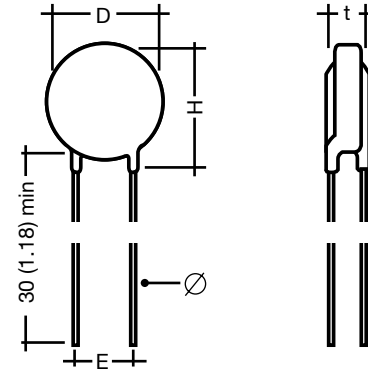

PARTICULAR CHARACTERISTICS

UL and CSA approval	VE Series	VF Series	Maximum operating voltage		Nominal voltage at 1 mA dc		
	P/N codification using (D_{max} , V_{rms})	P/N codification using ($d_{ceramic}$, V_{1mA})	V_{rms}	V_{DC}	$V_{1mA\ mini}$	$V_{1mA\ nominal}$	$V_{1mA\ max}$
	VE07M00110K __ VE09M00110K __	VF05M10180K __ VF07M10180K __	11	14	16.0	18	20.0
	VE07M00140K __ VE09M00140K __ VE13M00140K __ VE17M00140K __	VF05M10220K __ VF07M10220K __ VF10M10220K __ VF14M10220K __	14	18	19.8	22	24.2
★ ★ Pending Pending	VE07M00170K __ VE09M00170K __ VE13M00170K __ VE17M00170K __	VF05M10270K __ VF07M10270K __ VF10M10270K __ VF14M10270K __	17	22	24.0	27	30.0
★ ★ Pending Pending	VE07M00200K __ VE09M00200K __ VE13M00200K __ VE17M00200K __	VF05M10330K __ VF07M10330K __ VF10M10330K __ VF14M10330K __	20	26	29.5	33	36.5
★ ★ ★ ★	VE07M00250K __ VE09M00250K __ VE13M00250K __ VE17M00250K __	VF05M10390K __ VF07M10390K __ VF10M10390K __ VF14M10390K __	25	31	35	39	43
★ ★ ★ ★	VE07M00300K __ VE09M00300K __ VE13M00300K __ VE17M00300K __	VF05M10470K __ VF07M10470K __ VF10M10470K __ VF14M10470K __	30	38	42	47	52
★ ★ ★ ★	VE07M00350K __ VE09M00350K __ VE13M00350K __ VE17M00350K __	VF05M10560K __ VF07M10560K __ VF10M10560K __ VF14M10560K __	35	45	50	56	62
★ ★ ★ ★	VE07M00400K __ VE09M00400K __ VE13M00400K __ VE17M00400K __	VF05M10680K __ VF07M10680K __ VF10M10680K __ VF14M10680K __	40	56	61	68	75
★ ★ ★ ★	VE07M00500K __ VE09M00500K __ VE13M00500K __ VE17M00500K __	VF05M10820K __ VF07M10820K __ VF10M10820K __ VF14M10820K __	50	65	73	82	91

Zinc Oxide Varistors



VE 07/09/13/17/24

VF 05/07/10/14/20

DIMENSIONS millimeters (inches)

Type	Type	D		H max.	t max.	Ø +10% -0.05 (.002)	E ± 0.8
		Ceramic diameter	Maximum coated diameter				
VE07	VF05	5 (.196)	7 (.275)	10 (.394)		0.6 (.024)	5.08 (0.20)
VE09	VF07	7 (.275)	9 (.354)	12 (.472)		0.6 (.024)	5.08 (0.20)
VE13*	VF10*	10 (.393)	13* (.512)	16 (.630)	see table	0.8* (.031)	7.62*(0.30)
VE17	VF14	14 (.551)	17 (.669)	20 (.787)		0.8 (.031)	7.62 (0.30)
VE24**	VF20**	20 (.787)	24 (.945)	27 (1.06)		0.8** (.031)	7.62 (0.30)

* VE13 / VF10: For models with V_{RMS} 320 V
 other version/suffixes available with:
 E = 5.08 (0.20) Suffix:
 Ø = 0.6 (.024) Bulk: HB
 D = 12.5 (.492) max Tape: DA, DB, DC,
 DD, DQ, ...

**VE24 / VF20: For lead diameter = 1.0 (.039),
 please consult us.

GENERAL CHARACTERISTICS

Storage temperature: -40°C to +125°C
 Max. operating temperature: +85°C
 Response time: < 25 ns
 Voltage coefficient temp.: $|K| < 0.09\%/^{\circ}C$
 Voltage proof: 2500 V
 Epoxy coating: Flame retardant
 UL94-VO

MARKING

Type
 AC nominal voltage (EIA coding) for VE types
 V_{1mA} varistor voltage (EIA coding) for VF types
 Logo
 UL logo (when approved)
 Lot number (VE13/17/24 and VF10/14/20 only)

Max. clamping voltage (8 x 20 µs)		Max. energy absorption (10 x 1000 µs) W (J)		Max. permissible peak current (8 x 20 µs) Ip (A)		Typical capacitance f = 1kHz pF	Mean power dissipation W	Maximum thickness t mm (inches)	V/I characteristic Page	Derating curves Page
Vp (V)	Ip (A)	Number of surges 1	10	1 surge	2 surges					
43	1	0.4	0.2	100	50	1050	0.01	3.6 (.142)	22	24
43	2.5	0.9	0.6	250	125	1900	0.02	3.6 (.142)	22	25
43	5	2	1.3	500	250	4000	0.05	4.3 (.169)	22	26
43	10	4	2.6	1000	500	4000	0.10	4.3 (.169)	23	27
53	1	0.5	0.3	100	50	1050	0.01	3.7 (.146)	22	24
53	2.5	1.1	0.7	250	125	1900	0.02	3.7 (.146)	22	25
53	5	2.5	1.6	500	250	4000	0.05	4.3 (.169)	22	26
53	10	4.7	3.0	1000	500	6800	0.10	4.3 (.169)	23	27
65	1	0.6	0.3	100	50	750	0.01	3.9 (.154)	22	24
65	2.5	1.3	0.9	250	125	1500	0.02	3.9 (.154)	22	25
65	5	3.1	2.0	500	250	3100	0.05	4.5 (.177)	22	26
65	10	5.7	4.0	1000	500	5700	0.10	4.5 (.177)	23	27
77	1	0.7	0.4	100	50	660	0.01	3.6 (.142)	22	24
77	2.5	1.6	1.0	250	125	1250	0.02	3.6 (.142)	22	25
77	5	3.7	3	500	250	2800	0.05	4.4 (.173)	22	26
77	10	7	5	1000	500	4600	0.10	4.4 (.173)	23	27
93	1	0.9	0.4	100	50	580	0.01	3.8 (.150)	22	24
93	2.5	2.0	1	250	125	1050	0.02	3.8 (.150)	22	25
93	5	4.4	4	500	250	2150	0.05	4.4 (.173)	22	26
93	10	9.0	7	1000	500	3500	0.10	4.4 (.173)	23	27
110	1	1.1	0.4	100	50	460	0.01	3.9 (.154)	22	24
110	2.5	2.5	1	250	125	850	0.02	3.9 (.154)	22	25
110	5	5.4	4.4	500	250	1900	0.05	4.7 (.185)	22	26
110	10	10.0	8	1000	500	3100	0.10	4.7 (.185)	23	27
135	1	1.3	0.5	100	50	400	0.01	4.1 (.161)	22	24
135	2.5	3.0	1	250	125	720	0.02	4.1 (.161)	22	25
135	5	8.4	5.9	500	250	1700	0.05	4.9 (.193)	22	26
135	10	13.0	8.5	1000	500	2800	0.10	4.9 (.193)	23	27
135	5	1.8	0.6	400	200	300	0.1	3.5 (.138)	22	24
135	10	4.2	1.6	1200	600	530	0.2	3.5 (.138)	22	25
135	25	8.4	6	2500	1250	950	0.4	4.1 (.161)	22	26
135	50	15.0	11	4500	2500	1800	0.6	4.1 (.161)	23	27

Zinc Oxide Varistors



VE 07/09/13/17/24

VF 05/07/10/14/20

UL and CSA approval	VE Series P/N codification using (D_{max} , V_{rms})	VF Series P/N codification using ($d_{ceramic}$, V_{1mA})	Maximum operating voltage		Nominal voltage at 1 mA dc		
			V_{rms}	V_{DC}	$V_{1mA\ mini}$	$V_{1mA\ nominal}$	$V_{1mA\ maxi}$
★ ★ ★ ★	VE07M00600K __ VE09M00600K __ VE13M00600K __ VE17M00600K __	VF05M10101K __ VF07M10101K __ VF10M10101K __ VF14M10101K __	60	80	90	100	110
★ ★ ★ ★ ★	VE07M00750K __ VE09M00750K __ VE13M00750K __ VE17M00750K __ VE24M00750K __	VF05M10121K __ VF07M10121K __ VF10M10121K __ VF14M10121K __ VF20M10121K __	75	100	108	120	132
★ ★ ★ ★ ★	VE07M00950K __ VE09M00950K __ VE13M00950K __ VE17M00950K __ VE24M00950K __	VF05M10151K __ VF07M10151K __ VF10M10151K __ VF14M10151K __ VF20M10151K __	95	125	135	150	165
★ ★ ★ ★ ★	VE07M01150K __ VE09M01150K __ VE13M01150K __ VE17M01150K __ VE24M01150K __	VF05M10181K __ VF07M10181K __ VF10M10181K __ VF14M10181K __ VF20M10181K __	115	150	162	180	198
★ ★ ★ ★ ★	VE07M00131K __ VE09M00131K __ VE13M00131K __ VE17M00131K __ VE24M00131K __	VF05M12050K __ VF07M12050K __ VF10M12050K __ VF14M12050K __ VF20M12050K __	130	170	184	205	226
★ ★ ★ ★ ★	VE07M00141K __ VE09M00141K __ VE13M00141K __ VE17M00141K __ VE24M00141K __	VF05M10221K __ VF07M10221K __ VF10M10221K __ VF14M10221K __ VF20M10221K __	140	180	198	220	242
★ ★ ★ ★ ★	VE07M00151K __ VE09M00151K __ VE13M00151K __ VE17M00151K __ VE24M00151K __	VF05M10241K __ VF07M10241K __ VF10M10241K __ VF14M10241K __ VF20M10241K __	150	200	216	240	264
★ ★ ★ ★ ★	VE07M01750K __ VE09M01750K __ VE13M01750K __ VE17M01750K __ VE24M01750K __	VF05M10271K __ VF07M10271K __ VF10M10271K __ VF14M10271K __ VF20M10271K __	175	225	243	270	297
★ ★ ★ ★ ★	VE07M00211K __ VE09M00211K __ VE13M00211K __ VE17M00211K __ VE24M00211K __	VF05M10331K __ VF07M10331K __ VF10M10331K __ VF14M10331K __ VF20M10331K __	210	275	297	330	363
★ ★ ★ ★ ★	VE07M00231K __ VE09M00231K __ VE13M00231K __ VE17M00231K __ VE24M00231K __	VF05M10361K __ VF07M10361K __ VF10M10361K __ VF14M10361K __ VF20M10361K __	230	300	324	360	396

Zinc Oxide Varistors



VE 07/09/13/17/24

VF 05/07/10/14/20

Max. clamping voltage (8 x 20 μ s)		Max. energy absorption (10 x 1000 μ s) W (J)		Max. permissible peak current (8 x 20 μ s)		Typical capacitance f = 1kHz pF	Mean power dissipation W	Maximum thickness t mm (inches)	V/I characteristic	Derating curves
Vp (V)	Ip (A)	Number of surges		Ip (A)					Page	Page
		1	10	1 surge	2 surges					
165	5	2.2	0.7	400	200	165	0.1	3.8 (.150)	22	24
165	10	4.8	1.7	1200	600	440	0.2	3.8 (.150)	22	25
165	25	10	7	2500	1250	870	0.4	4.5 (.177)	22	26
165	50	17	14	4500	2500	2200	0.6	4.5 (.177)	23	27
200	5	2.5	0.8	400	200	150	0.1	4.0 (.157)	22	24
200	10	5.9	1.8	1200	600	400	0.2	4.0 (.157)	22	25
200	25	12	8	2500	1250	700	0.4	4.4 (.173)	22	26
200	50	20	15	4500	2500	1900	0.6	4.4 (.173)	23	27
200	100	40	30	6500	4000	4200	0.8	4.8 (.189)	23	28
250	5	3.4	1	400	200	110	0.1	4.4 (.173)	22	24
250	10	7.6	3	1200	600	310	0.2	4.4 (.173)	22	25
250	25	15	9	2500	1250	560	0.4	5.0 (.197)	22	26
250	50	25	20	4500	2500	1200	0.6	5.0 (.197)	23	27
250	100	50	33	6500	4000	3400	0.8	5.4 (.213)	23	28
300	5	3.6	1.3	400	200	100	0.1	4.5 (.177)	22	24
300	10	8.4	3.3	1200	600	280	0.2	4.5 (.177)	22	25
300	25	18	10.6	2500	1250	500	0.4	5.1 (.201)	22	26
300	50	30	22	4500	2500	1100	0.6	5.1 (.201)	23	27
300	100	60	40	6500	4000	3000	0.8	5.5 (.217)	23	28
340	5	4.2	1.5	400	200	90	0.1	4.1 (.161)	22	24
340	10	9.5	4	1200	600	250	0.2	4.1 (.161)	22	25
340	25	19	11	2500	1250	450	0.4	4.7 (.185)	22	26
340	50	34	25	4500	2500	1000	0.6	4.7 (.185)	23	27
340	100	74	46	6500	4000	2500	0.8	5.1 (.201)	23	28
360	5	4.5	1.5	400	200	85	0.1	4.2 (.165)	22	24
360	10	10	4	1200	600	235	0.2	4.2 (.165)	22	25
360	25	22	12.5	2500	1250	425	0.4	4.8 (.189)	22	26
360	50	36	26.5	4500	2500	930	0.6	4.8 (.189)	23	27
360	100	78	50	6500	4000	2250	0.8	5.2 (.205)	23	28
400	5	4.9	1.8	400	200	80	0.1	4.3 (.169)	22	24
400	10	11	4.1	1200	600	220	0.2	4.3 (.169)	22	25
400	25	24	13	2500	1250	400	0.4	4.9 (.193)	22	26
400	50	40	30	4500	2500	850	0.6	4.9 (.193)	23	27
400	100	85	56	6500	4000	2000	0.8	5.3 (.209)	23	28
445	5	5.6	1.9	400	200	70	0.1	4.5 (.177)	22	24
445	10	13	4.5	1200	600	190	0.2	4.5 (.177)	22	25
445	25	28	13.5	2500	1250	340	0.4	5.1 (.201)	22	26
445	50	46	31	4500	2500	750	0.6	5.1 (.201)	23	27
445	100	98	56	6500	4000	2000	0.8	5.5 (.217)	23	28
545	5	7.2	2.2	400	200	60	0.1	4.9 (.193)	22	24
545	10	15	5.4	1200	600	155	0.2	4.9 (.193)	22	25
545	25	31	14.0	2500	1250	275	0.4	5.5 (.217)	22	26
545	50	54	35	4500	2500	600	0.6	5.5 (.217)	23	27
545	100	115	70	6500	4000	1650	0.8	5.9 (.232)	23	28
595	5	7.2	2.4	400	200	55	0.1	5.1 (.201)	22	24
595	10	17	6	1200	600	140	0.2	5.1 (.201)	22	25
595	25	36	14.3	2500	1250	250	0.4	5.7 (.224)	22	26
595	50	60	38	4500	2500	550	0.6	5.7 (.224)	23	27
595	100	130	75	6500	4000	1500	0.8	6.1 (.240)	23	28

Zinc Oxide Varistors



VE 07/09/13/17/24

VF 05/07/10/14/20

UL and CSA approval	VE Series P/N codification using	VF Series P/N codification using	Maximum operating voltage		Nominal voltage at 1 mA dc		
	(D _{max} , V _{rms})	(d _{ceramic} , V _{1mA})	V _{rms}	V _{DC}	V _{1mA mini}	V _{1mA nominal}	V _{1mA maxi}
★	VE07M00251K __	VF05M10391K __	250	320	351	390	429
★	VE09M00251K __	VF07M10391K __					
★	VE13M00251K __	VF10M10391K __					
★	VE17M00251K __	VF14M10391K __					
★	VE24M00251K __	VF20M10391K __					
★	VE07M02750K __	VF05M10431K __	275	350	387	430	473
★	VE09M02750K __	VF07M10431K __					
★	VE13M02750K __	VF10M10431K __					
★	VE17M02750K __	VF14M10431K __					
★	VE24M02750K __	VF20M10431K __					
★	VE07M00301K __	VF05M10471K __	300	385	423	470	517
★	VE09M00301K __	VF07M10471K __					
★	VE13M00301K __	VF10M10471K __					
★	VE17M00301K __	VF14M10471K __					
★	VE24M00301K __	VF20M10471K __					
★	VE09M00321K __	VF07M10511K __	320	420	459	510	561
★	VE13M00321K __	VF10M10511K __					
★	VE17M00321K __	VF14M10511K __					
★	VE24M00321K __	VF20M10511K __					
★	VE09M00351K __	VF07M10561K __	350	460	504	560	616
★	VE13M00351K __	VF10M10561K __					
★	VE17M00351K __	VF14M10561K __					
★	VE24M00351K __	VF20M10561K __					
★	VE09M03850K __	VF07M10621K __	385	505	558	620	682
★	VE13M03850K __	VF10M10621K __					
★	VE17M03850K __	VF14M10621K __					
★	VE24M03850K __	VF20M10621K __					
★	VE09M00421K __	VF07M10681K __	420	560	612	680	748
★	VE13M00421K __	VF10M10681K __					
★	VE17M00421K __	VF14M10681K __					
★	VE24M00421K __	VF20M10681K __					
★	VE13M00441K __	VF10M17150K __	440	585	643	715	787
★	VE17M00441K __	VF14M17150K __					
★	VE24M00441K __	VF20M17150K __					
★	VE13M00461K __	VF10M10751K __	460	615	675	750	825
★	VE17M00461K __	VF14M10751K __					
★	VE24M00461K __	VF20M10751K __					
★	VE13M00511K __	VF10M10821K __	510	670	738	820	902
★	VE17M00511K __	VF14M10821K __					
★	VE24M00511K __	VF20M10821K __					
★	VE13M00551K __	VF10M10861K __	550	715	774	860	946
★	VE17M00551K __	VF14M10861K __					
★	VE24M00551K __	VF20M10861K __					
★	VE13M05750K __	VF10M10911K __	575	730	819	910	1001
★	VE17M05750K __	VF14M10911K __					
★	VE24M05750K __	VF20M10911K __					
★	VE13M06250K __	VF10M10102K __	625	825	900	1000	1100
★	VE17M06250K __	VF14M10102K __					
★	VE24M06250K __	VF20M10102K __					

Zinc Oxide Varistors



VE 07/09/13/17/24

VF 05/07/10/14/20

Max. clamping voltage (8 x 20 μs)		Max. energy absorption (10 x 1000 μs) W (J)		Max. permissible peak current (8 x 20 μs) Ip (A)		Typical capacitance f = 1kHz	Mean power dissipation	Maximum thickness t	V/I characteristic	Derating curves
Vp (V)	Ip (A)	Number of surges		1 surge	2 surges	pF	W	mm (inches)	Page	Page
		1	10							
645	5	8.2	2.8	400	200	50	0.1	5.4 (.213)	22	24
645	10	19	7.3	1200	600	130	0.2	5.4 (.213)	22	25
645	25	38	19	2500	1250	230	0.4	5.9 (.232)	22	26
645	50	65	39	4500	2500	500	0.6	5.9 (.232)	23	27
645	100	140	100	6500	4000	1300	0.8	6.3 (.248)	23	28
710	5	8.6	3	400	200	45	0.1	5.7 (.224)	22	24
710	10	21	7.4	1200	600	120	0.2	5.7 (.224)	22	25
710	25	43	20	2500	1250	210	0.4	6.3 (.248)	22	26
710	50	71	40	4500	2500	450	0.6	6.3 (.248)	23	27
710	100	151	105	6500	4000	1200	0.8	6.7 (.264)	23	28
775	5	9	3.3	400	200	40	0.1	6.0 (.236)	22	24
775	10	25	7.5	1200	600	100	0.2	6.0 (.236)	22	25
775	25	45	20	2500	1250	180	0.4	6.6 (.260)	22	26
775	50	80	42	4500	2500	400	0.6	6.6 (.260)	23	27
775	100	150	107	6500	4000	1000	0.8	7.0 (.276)	23	28
840	10	25	7.5	1200	600	100	0.2	6.4 (.252)	22	25
840	25	45	20	2500	1250	170	0.4	7.0 (.276)	22	26
840	50	82	42	4500	2500	380	0.6	7.0 (.276)	23	27
840	100	150	107	6500	4000	950	0.8	7.5 (.276)	23	28
910	10	25	7.5	1200	600	95	0.2	6.6 (.260)	22	25
910	25	45	20	2500	1250	160	0.4	7.3 (.287)	22	26
910	50	85	42	4500	2500	365	0.6	7.3 (.287)	23	27
910	100	155	107	6500	4000	900	0.8	7.8 (.307)	23	28
1025	10	25	7.5	1200	600	95	0.2	7.0 (.276)	22	25
1025	25	45	20	2500	1250	150	0.4	7.7 (.303)	22	26
1025	50	88	42	4500	2500	350	0.6	7.7 (.303)	23	27
1025	100	155	107	6500	4000	850	0.8	8.1 (.319)	23	28
1120	10	25	7.5	1200	600	80	0.2	7.4 (.291)	22	25
1120	25	45	20	2500	1250	120	0.4	8.2 (.323)	22	26
1120	50	90	42	4500	2500	300	0.6	8.2 (.323)	23	27
1120	100	160	107	6500	4000	700	0.8	8.6 (.339)	23	28
1180	25	45	20	2500	1250	115	0.4	8.4 (.331)	22	26
1180	50	95	44	4500	2500	275	0.6	8.4 (.331)	23	27
1180	100	165	115	6500	4000	650	0.8	8.8 (.346)	23	28
1240	25	45	20	2500	1250	110	0.4	8.5 (.335)	22	26
1240	50	100	47	4500	2500	250	0.6	8.5 (.335)	23	27
1240	100	175	120	6500	4000	600	0.8	9.0 (.354)	23	28
1350	25	55	22	2500	1250	100	0.4	9.0 (.354)	22	26
1350	50	110	57	4500	2500	220	0.6	9.0 (.354)	23	27
1350	100	190	150	6500	4000	550	0.8	9.4 (.370)	23	28
1420	25	57	24	2500	1250	90	0.4	9.3 (.366)	22	26
1420	50	113	57	4500	2500	200	0.6	9.3 (.366)	23	27
1420	100	200	150	6500	4000	500	0.8	9.7 (.382)	23	28
1500	25	60	25	2500	1250	80	0.4	9.7 (.382)	22	26
1500	50	120	60	4500	2500	180	0.6	9.7 (.382)	23	27
1500	100	210	160	6500	4000	450	0.8	10.1 (.398)	23	28
1650	25	68	25	2500	1250	74	0.4	10.5 (.413)	22	26
1650	50	130	60	4500	2500	165	0.6	10.5 (.413)	23	27
1650	100	230	160	6500	4000	410	0.8	11.0 (.433)	23	28

Zinc Oxide Varistors



VE/VF Types for Heavy Duty Applications (“P Series”)

FEATURES

- “P Series” are especially dedicated to heavy duty applications encountered in the AC power network. Higher surge current and energy ratings provide an improved protection and a better reliability
- Radial lead varistors
- Operating voltage range from 130 V to 625 V (V_{rms} for VE types) or 205 V to 1000 V (V_{1mA} for VF types)
- Available in tape and reel for use with automatic insertion equipment (see pages 31 to 33 for details).

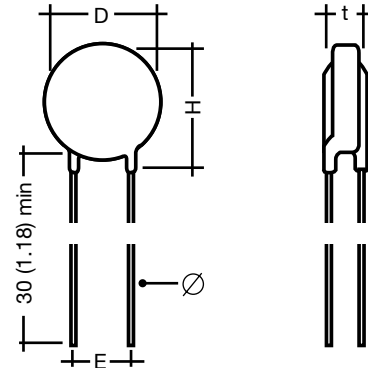

PARTICULAR CHARACTERISTICS

VE Series P/N codification using (D_{max} , V_{rms})	VF Series P/N codification using ($d_{ceramics}$, V_{1mA})	Maximum operating voltage		Nominal voltage at 1 mA dc		
		V_{rms}	V_{DC}	$V_{1mA\ mini}$	$V_{1mA\ nominal}$	$V_{1mA\ maxi}$
VE07P00131K __ VE09P00131K __ VE13P00131K __ VE17P00131K __ VE24P00131K __	VF05P12050K __ VF07P12050K __ VF10P12050K __ VF14P12050K __ VF20P12050K __	130	170	184	205	226
VE07P00141K __ VE09P00141K __ VE13P00141K __ VE17P00141K __ VE24P00141K __	VF05P10221K __ VF07P10221K __ VF10P10221K __ VF14P10221K __ VF20P10221K __	140	180	198	220	242
VE07P00151K __ VE09P00151K __ VE13P00151K __ VE17P00151K __ VE24P00151K __	VF05P10241K __ VF07P10241K __ VF10P10241K __ VF14P10241K __ VF20P10241K __	150	200	216	240	264
VE07P01750K __ VE09P01750K __ VE13P01750K __ VE17P01750K __ VE24P01750K __	VF05P10271K __ VF07P10271K __ VF10P10271K __ VF14P10271K __ VF20P10271K __	175	225	243	270	297
VE07P00211K __ VE09P00211K __ VE13P00211K __ VE17P00211K __ VE24P00211K __	VF05P10331K __ VF07P10331K __ VF10P10331K __ VF14P10331K __ VF20P10331K __	210	275	297	330	363
VE07P00231K __ VE09P00231K __ VE13P00231K __ VE17P00231K __ VE24P00231K __	VF05P10361K __ VF07P10361K __ VF10P10361K __ VF14P10361K __ VF20P10361K __	230	300	324	360	396

Zinc Oxide Varistors



VE/VF Types for Heavy Duty Applications (“P Series”)

DIMENSIONS millimeters (inches)

Type	Type	D		H max.	t max.	Ø +10% -0.05 (.002)	E ± 0.8
		Ceramic diameter	Maximum coated diameter				
VE07	VF05	5 (.196)	7 (.275)	10 (.394)		0.6 (.024)	5.08 (0.20)
VE09	VF07	7 (.275)	9 (.354)	12 (.472)		0.6 (.024)	5.08 (0.20)
VE13*	VF10*	10 (.393)	13* (.512)	16 (.630)	see table	0.8* (.031)	7.62*(0.30)
VE17	VF14	14 (.551)	17 (.669)	20 (.787)		0.8 (.031)	7.62 (0.30)
VE24**	VF20**	20 (.787)	24 (.945)	27 (1.06)		0.8** (.031)	7.62 (0.30)

GENERAL CHARACTERISTICS

Storage temperature: -40°C to +125°C
 Max. operating temperature: +85°C
 Response time: < 25 ns
 Voltage coefficient temp.: |K| < 0.09%/°C
 Voltage proof: 2500 V
 Epoxy coating: Flame retardant UL94-VO

MARKING

Type
 AC nominal voltage (EIA coding) for VE types
 V_{1mA} varistor voltage (EIA coding) for VF types
 Logo
 UL logo (when approved)
 Lot number (VE13/17/24 and VF10/14/20 only)

* VE13 / VF10: For models with V_{RMS} ≤ 320 V
 other version/suffixes available with:
 E = 5.08 (0.20) Suffix:
 Ø = 0.6 (.024) Bulk: HB
 D = 12.5 (.492) max Tape: DA, DB, DC,
 DD, DQ, ...

**VE24 / VF20: For lead diameter = 1.0 (.039),
 please consult us.

Max. clamping voltage (8 x 20 µs)		Max. energy absorption (10 x 1000 µs) W (J) Number of surges 1 surge	Max. permissible peak current (8 x 20 µs) Ip (A)		Typical capacitance f = 1kHz pF	Mean power dissipation W	Maximum thickness t mm (inches)	V/I characteristic Page	Derating curves Page
Vp (V)	Ip (A)		1 surge	2 surges					
340	5	8.5	800	600	90	0.1	4.1 (.161)	34	24
340	10	17.5	1750	1250	250	0.2	4.1 (.161)	34	25
340	25	35	3500	2500	450	0.4	4.7 (.185)	34	26
340	50	70	6000	4500	1000	0.6	4.7 (.185)	35	27
340	100	140	10000	7000	2500	0.8	5.1 (.201)	35	28
360	5	9	800	600	85	0.1	4.2 (.165)	34	24
360	10	19	1750	1250	235	0.2	4.2 (.165)	34	25
360	25	39	3500	2500	425	0.4	4.8 (.189)	34	26
360	50	78	6000	4500	930	0.6	4.8 (.189)	35	27
360	100	155	10000	7000	2250	0.8	5.2 (.205)	35	28
400	5	10.5	800	600	80	0.1	4.3 (.169)	34	24
400	10	21	1750	1250	220	0.2	4.3 (.169)	34	25
400	25	42	3500	2500	400	0.4	4.9 (.193)	34	26
400	50	85	6000	4500	850	0.6	4.9 (.193)	35	27
400	100	170	10000	7000	2000	0.8	5.3 (.209)	35	28
445	5	11	800	600	70	0.1	4.5 (.177)	34	24
445	10	24	1750	1250	190	0.2	4.5 (.177)	34	25
445	25	50	3500	2500	340	0.4	5.1 (.201)	34	26
445	50	100	6000	4500	750	0.6	5.1 (.201)	35	27
445	100	190	10000	7000	2000	0.8	5.5 (.217)	35	28
545	5	13	800	600	60	0.1	4.9 (.193)	34	24
545	10	28	1750	1250	155	0.2	4.9 (.193)	34	25
545	25	60	3500	2500	275	0.4	5.5 (.217)	34	26
545	50	115	6000	4500	600	0.6	5.5 (.217)	35	27
545	100	230	10000	7000	1650	0.8	5.9 (.232)	35	28
595	5	16	800	600	55	0.1	5.1 (.201)	34	24
595	10	32	1750	1250	140	0.2	5.1 (.201)	34	25
595	25	65	3500	2500	250	0.4	5.7 (.224)	34	26
595	50	130	6000	4500	550	0.6	5.7 (.224)	35	27
595	100	250	10000	7000	1500	0.8	6.1 (.240)	35	28

Zinc Oxide Varistors



VE/VF Types for Heavy Duty Applications (“P Series”)

VE Series P/N codification using (D _{max} , V _{rms})	VF Series P/N codification using (d _{ceramic} , V _{1mA})	Maximum operating voltage		Nominal voltage at 1 mA dc		
		V _{rms}	V _{dc}	V _{1mA mini}	V _{1mA nominal}	V _{1mA maxi}
VE07P00251K __ VE09P00251K __ VE13P00251K __ VE17P00251K __ VE24P00251K __	VF05P10391K __ VF07P10391K __ VF10P10391K __ VF14P10391K __ VF20P10391K __	250	320	351	390	429
VE07P02750K __ VE09P02750K __ VE13P02750K __ VE17P02750K __ VE24P02750K __	VF05P10431K __ VF07P10431K __ VF10P10431K __ VF14P10431K __ VF20P10431K __	275	350	387	430	473
VE07P00301K __ VE09P00301K __ VE13P00301K __ VE17P00301K __ VE24P00301K __	VF05P10471K __ VF07P10471K __ VF10P10471K __ VF14P10471K __ VF20P10471K __	300	385	423	470	517
VE09P00321K __ VE13P00321K __ VE17P00321K __ VE24P00321K __	VF07P10511K __ VF10P10511K __ VF14P10511K __ VF20P10511K __	320	420	459	510	561
VE09P00351K __ VE13P00351K __ VE17P00351K __ VE24P00351K __	VF07P10561K __ VF10P10561K __ VF14P10561K __ VF20P10561K __	350	460	504	560	616
VE09P03850K __ VE13P03850K __ VE17P03850K __ VE24P03850K __	VF07P10621K __ VF10P10621K __ VF14P10621K __ VF20P10621K __	385	505	558	620	682
VE09P00421K __ VE13P00421K __ VE17P00421K __ VE24P00421K __	VF07P10681K __ VF10P10681K __ VF14P10681K __ VF20P10681K __	420	560	612	680	748
VE13P00441K __ VE17P00441K __ VE24P00441K __	VF10P17150K __ VF14P17150K __ VF20P17150K __	440	585	643	715	787
VE13P00461K __ VE17P00461K __ VE24P00461K __	VF10P10751K __ VF14P10751K __ VF20P10751K __	460	615	675	750	825
VE13P00511K __ VE17P00511K __ VE24P00511K __	VF10P10821K __ VF14P10821K __ VF20P10821K __	510	670	738	820	902
VE13P00551K __ VE17P00551K __ VE24P00551K __	VF10P10861K __ VF14P10861K __ VF20P10861K __	550	715	774	860	946
VE13P05750K __ VE17P05750K __ VE24P05750K __	VF10P10911K __ VF14P10911K __ VF20P10911K __	575	730	819	910	1001
VE13P06250K __ VE17P06250K __ VE24P06250K __	VF10P10102K __ VF14P10102K __ VF20P10102K __	625	825	900	1000	1100

Zinc Oxide Varistors



VE/VF Types for Heavy Duty Applications (“P Series”)

Max. clamping voltage (8 x 20 μ s)		Max. energy absorption (10 x 1000 μ s) W (J) Number of surges 1 surge	Max. permissible peak current (8 x 20 μ s) Ip (A)		Typical capacitance f = 1kHz pF	Mean power dissipation W	Maximum thickness t mm (inches)	V/I characteristic	Derating curves
Vp (V)	Ip (A)		1 surge	2 surges				Page	Page
645	5	17	800	600	50	0.1	5.4 (.213)	34	24
645	10	35	1750	1250	130	0.2	5.4 (.213)	34	25
645	25	70	3500	2500	230	0.4	5.9 (.232)	34	26
645	50	140	6000	4500	500	0.6	5.9 (.232)	35	27
645	100	280	10000	7000	1300	0.8	6.3 (.248)	35	28
710	5	20	800	600	45	0.1	5.7 (.224)	34	24
710	10	40	1750	1250	120	0.2	5.7 (.224)	34	25
710	25	80	3500	2500	210	0.4	6.3 (.248)	34	26
710	50	160	6000	4500	450	0.6	6.3 (.248)	35	27
710	100	310	10000	7000	1200	0.8	6.7 (.264)	35	28
775	5	21	800	600	40	0.1	6.0 (.236)	34	24
775	10	42	1750	1250	100	0.2	6.0 (.236)	34	25
775	25	85	3500	2500	180	0.4	6.6 (.260)	34	26
775	50	170	6000	4500	400	0.6	6.6 (.260)	35	27
775	100	340	10000	7000	1000	0.8	7.0 (.276)	35	28
840	10	45	1750	1250	100	0.2	6.4 (.252)	34	25
840	25	90	3500	2500	170	0.4	7.0 (.276)	34	26
840	50	180	5000	4000	380	0.6	7.0 (.276)	35	27
840	100	360	8000	6000	950	0.8	7.5 (.295)	35	28
910	10	47	1750	1250	95	0.2	6.6 (.260)	34	25
910	25	95	3500	2500	160	0.4	7.3 (.287)	34	26
910	50	190	5000	4000	365	0.6	7.3 (.287)	35	27
910	100	380	8000	6000	900	0.8	7.8 (.307)	35	28
1025	10	50	1750	1250	95	0.2	7.0 (.276)	34	25
1025	25	100	3500	2500	150	0.4	7.7 (.303)	34	26
1025	50	200	5000	4000	350	0.6	7.7 (.303)	35	27
1025	100	400	8000	6000	850	0.8	8.1 (.319)	35	28
1120	10	52	1750	1250	80	0.2	7.4 (.291)	34	25
1120	25	105	3500	2500	120	0.4	8.2 (.323)	34	26
1120	50	210	5000	4000	300	0.6	8.2 (.323)	35	27
1120	100	420	8000	6000	700	0.8	8.6 (.339)	35	28
1180	25	105	3500	2500	115	0.4	8.4 (.331)	34	26
1180	50	210	5000	4000	275	0.6	8.4 (.331)	35	27
1180	100	420	8000	6000	650	0.8	8.8 (.346)	35	28
1240	25	105	3500	2500	110	0.4	8.5 (.335)	34	26
1240	50	210	5000	4000	250	0.6	8.5 (.335)	35	27
1240	100	420	8000	6000	600	0.8	9.0 (.354)	35	28
1350	25	110	3500	2500	100	0.4	9.0 (.354)	34	26
1350	50	225	5000	4000	220	0.6	9.0 (.354)	35	27
1350	100	450	7500	6000	550	0.8	9.4 (.370)	35	28
1420	25	120	3500	2500	90	0.4	9.3 (.366)	34	26
1420	50	240	5000	4000	200	0.6	9.3 (.366)	35	27
1420	100	480	7500	6000	500	0.8	9.7 (.382)	35	28
1500	25	125	3500	2500	80	0.4	9.7 (.382)	34	26
1500	50	250	5000	4000	180	0.6	9.7 (.382)	35	27
1500	100	500	7500	6000	450	0.8	10.1 (.398)	35	28
1650	25	140	3500	2500	74	0.4	10.5 (.413)	34	26
1650	50	230	5000	4000	165	0.6	10.5 (.413)	35	27
1650	100	560	7500	6000	410	0.8	11.0 (.433)	35	28

Zinc Oxide Varistors



Electrical Characteristics VE / VF Types

VOLTAGE-CURRENT CHARACTERISTICS

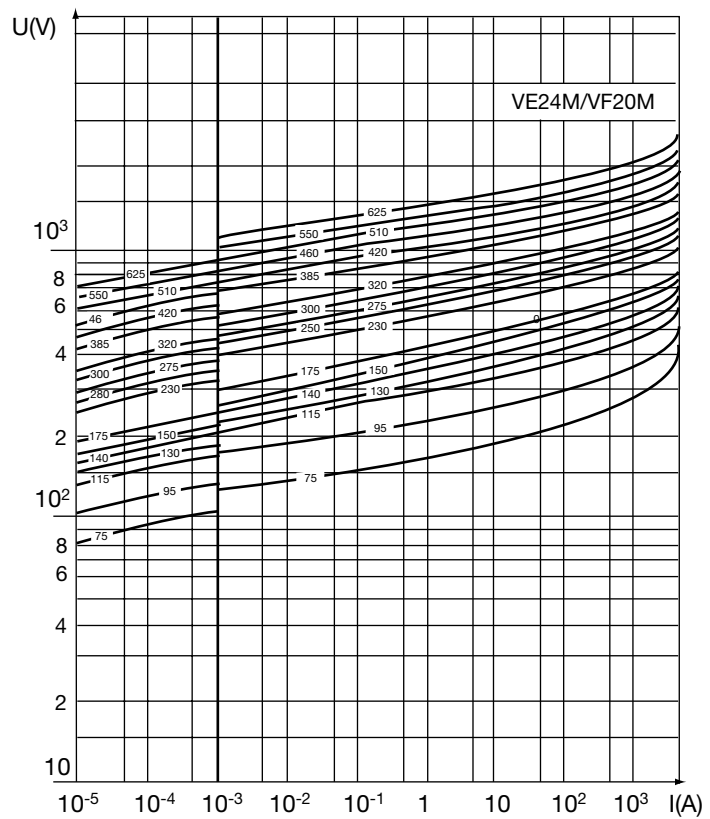
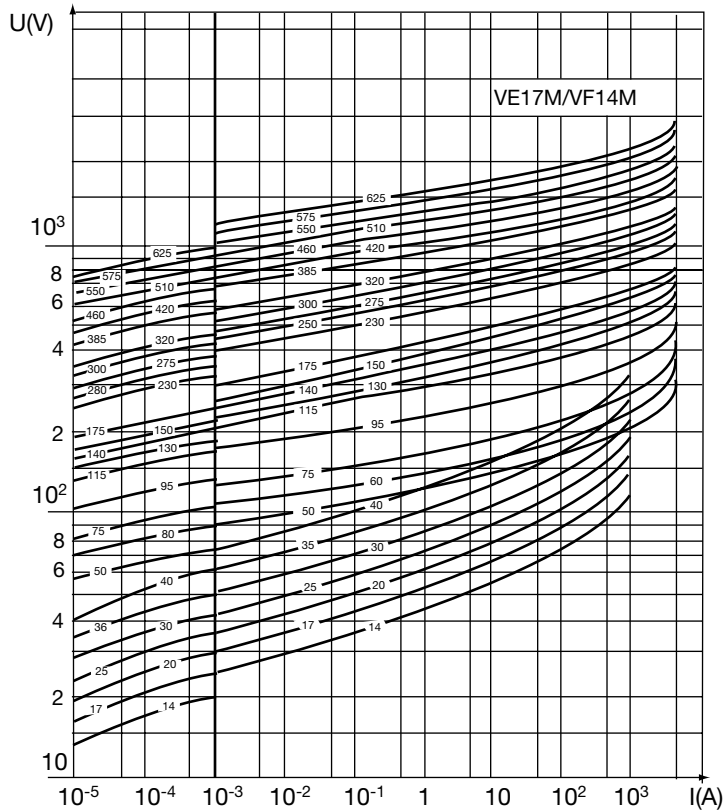

Zinc Oxide Varistors



Electrical Characteristics VE / VF Types

MAXIMUM SURGE CURRENT (I_p) DERATING CURVES WITH PULSE WIDTH (τ) AND FREQUENCY

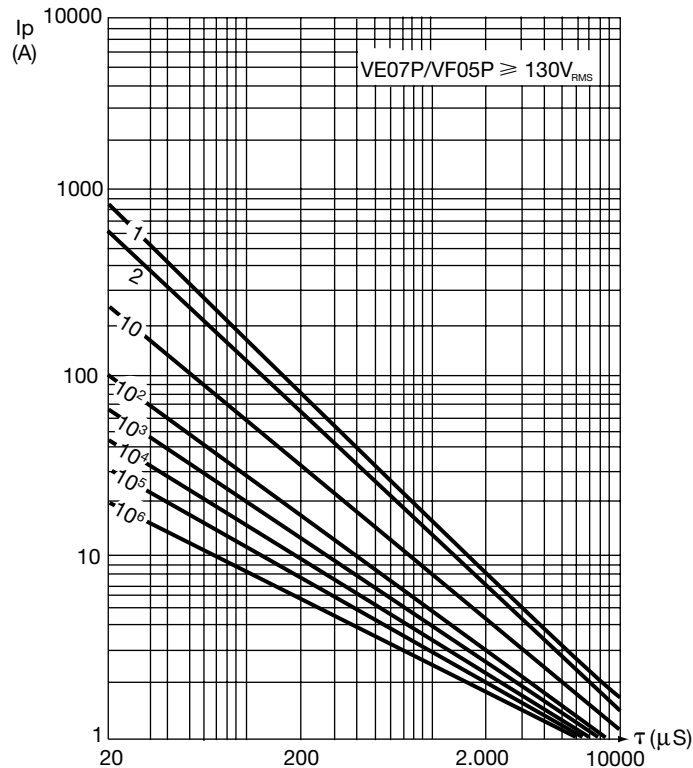
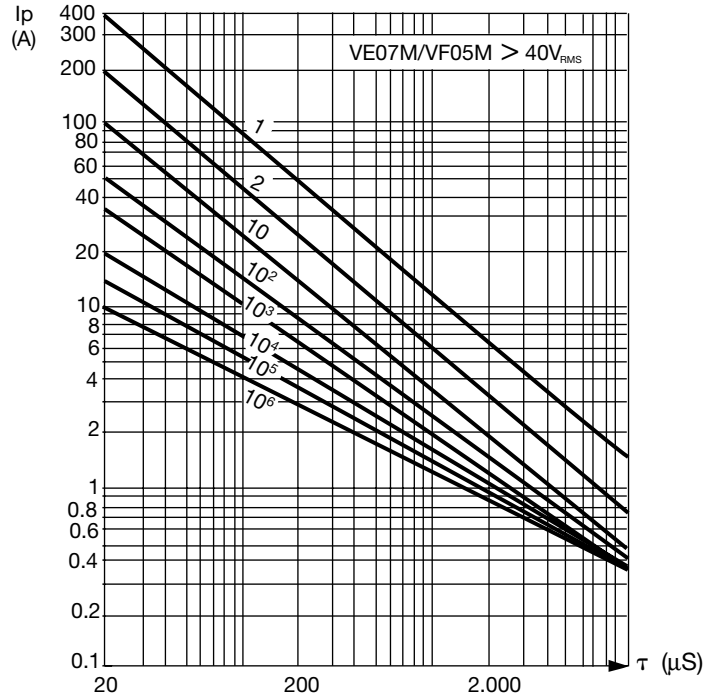
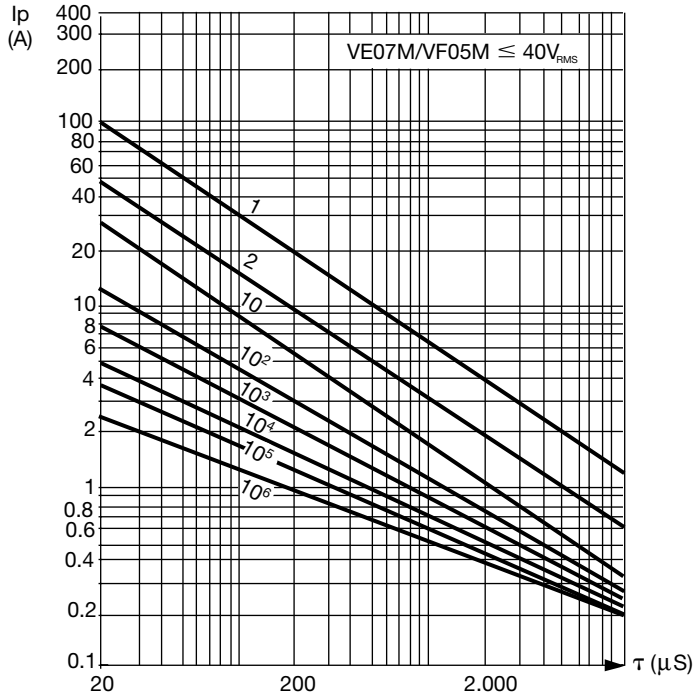

Zinc Oxide Varistors



Electrical Characteristics VE / VF Types

MAXIMUM SURGE CURRENT (I_p) DERATING CURVES WITH PULSE WIDTH (τ) AND FREQUENCY

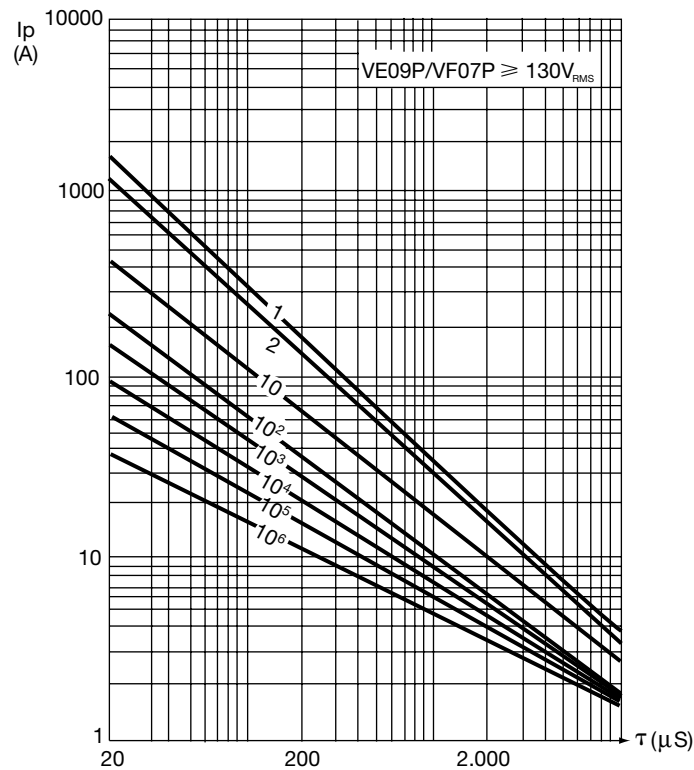
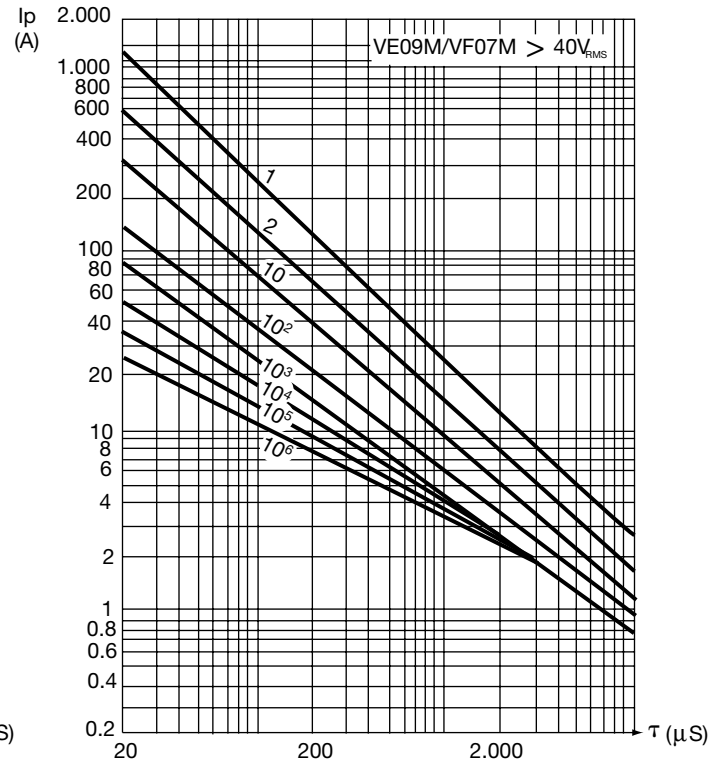
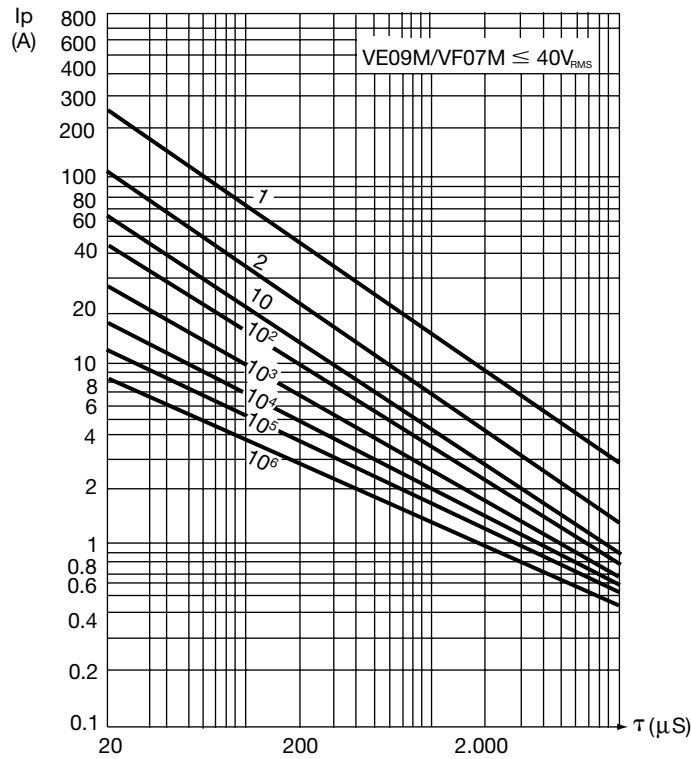

Zinc Oxide Varistors



Electrical Characteristics VE / VF Types

MAXIMUM SURGE CURRENT (I_p) DERATING CURVES WITH PULSE WIDTH (τ) AND FREQUENCY

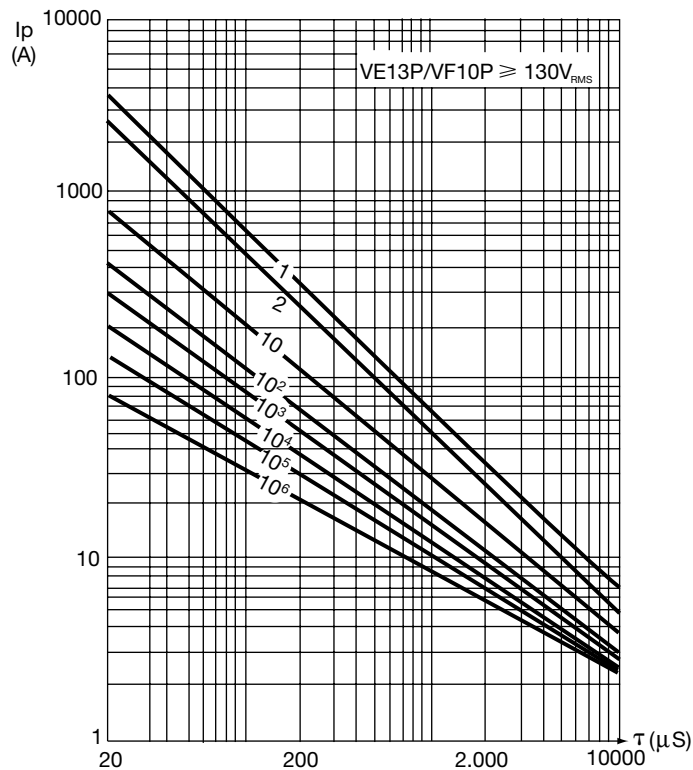
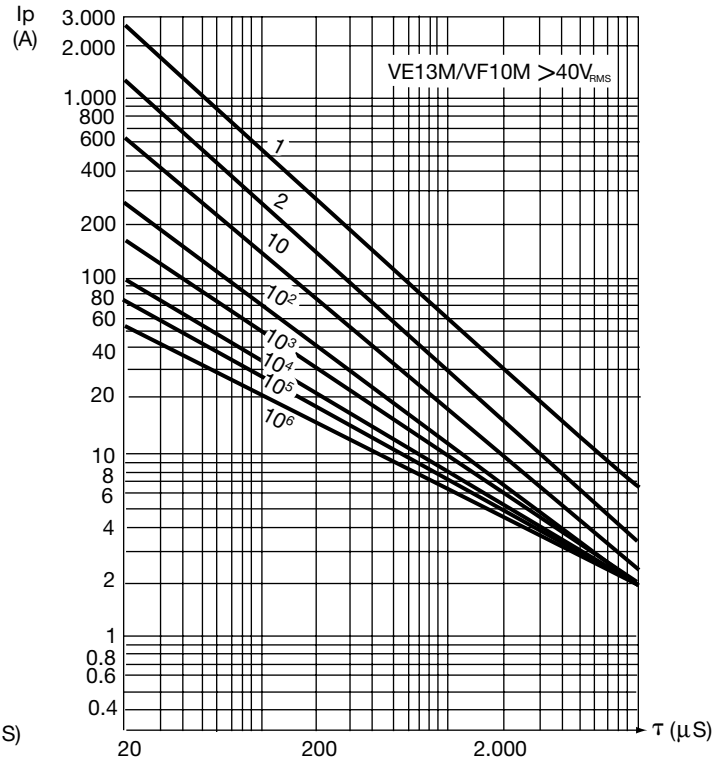
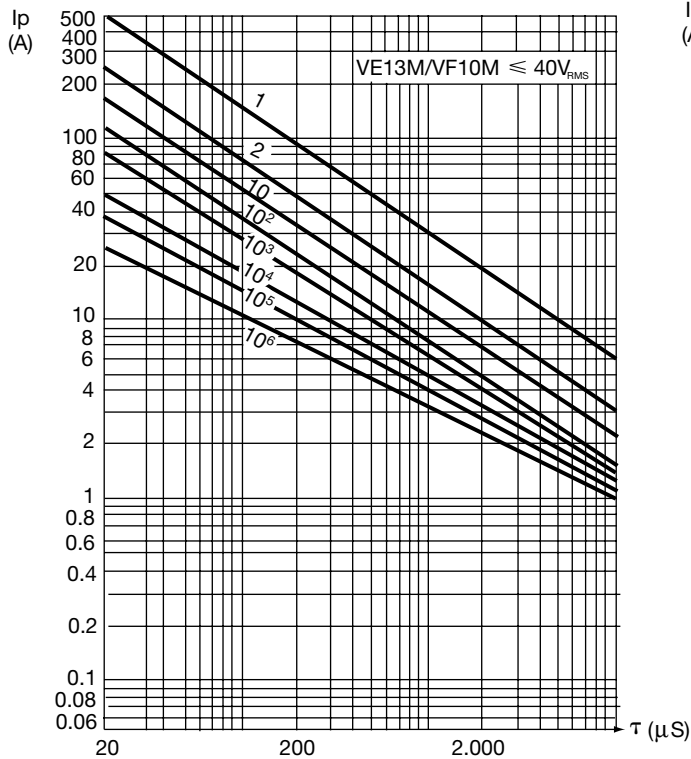

Zinc Oxide Varistors



Electrical Characteristics VE / VF Types

MAXIMUM SURGE CURRENT (I_p) DERATING CURVES WITH PULSE WIDTH (τ) AND FREQUENCY

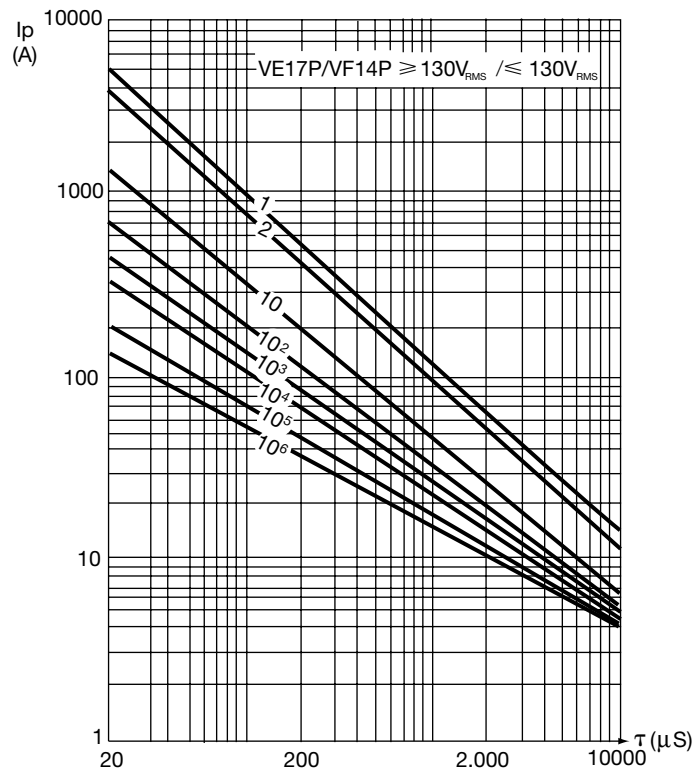
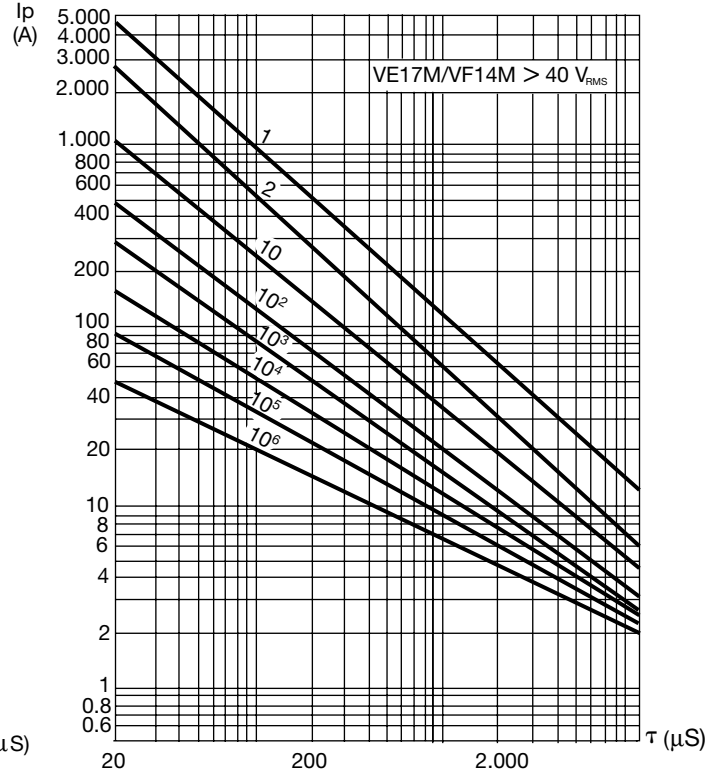
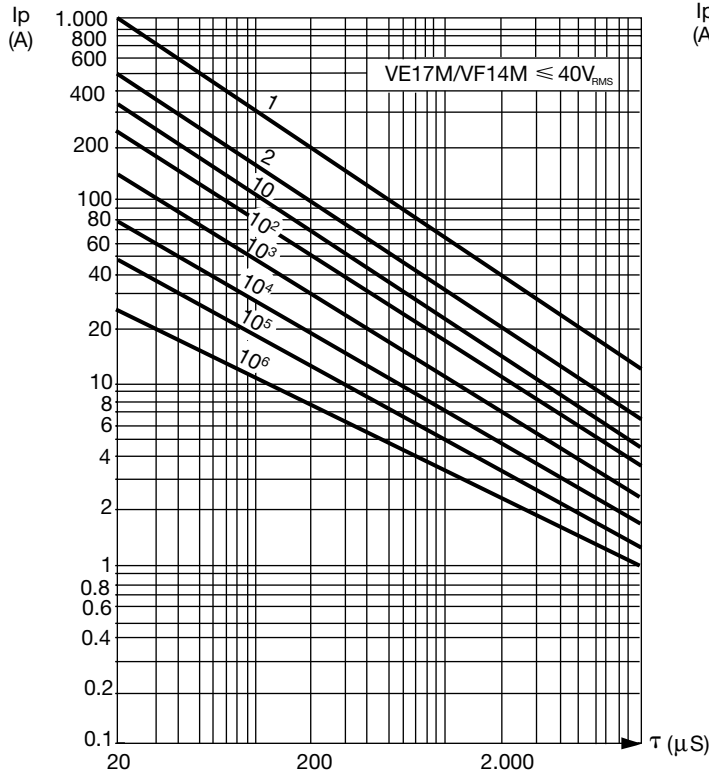

Zinc Oxide Varistors



Electrical Characteristics VE / VF Types

MAXIMUM SURGE CURRENT (I_p) DERATING CURVES WITH PULSE WIDTH (τ) AND FREQUENCY

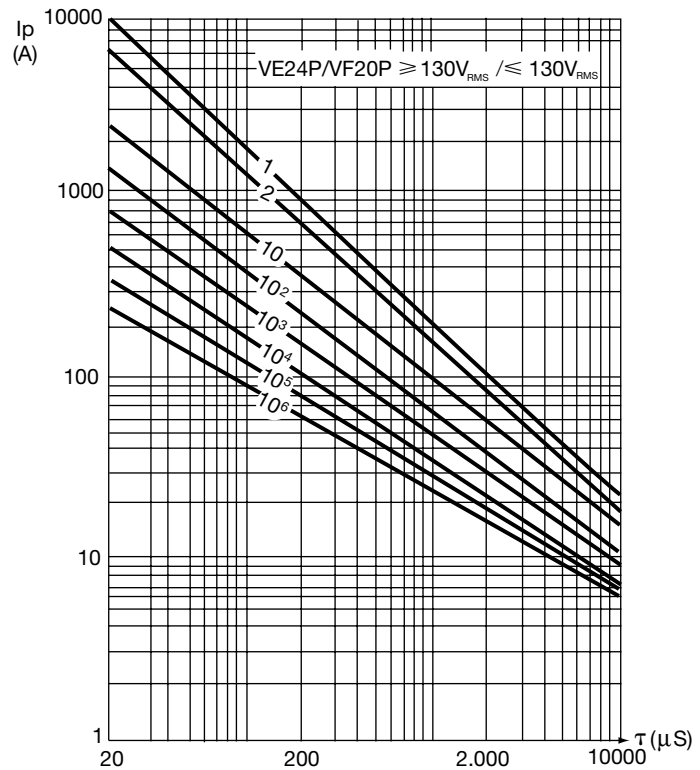
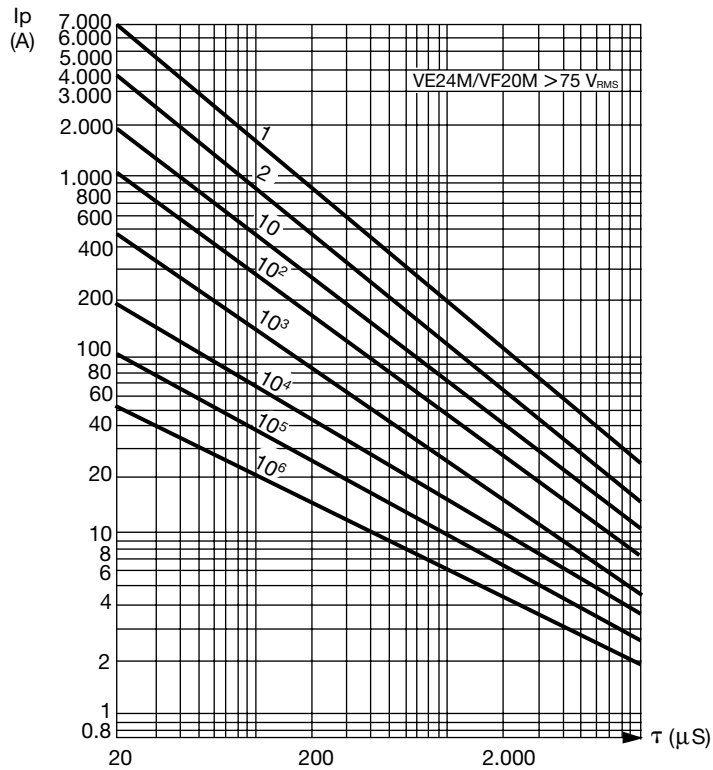

Zinc Oxide Varistors



VN 32 Uncoated Discs

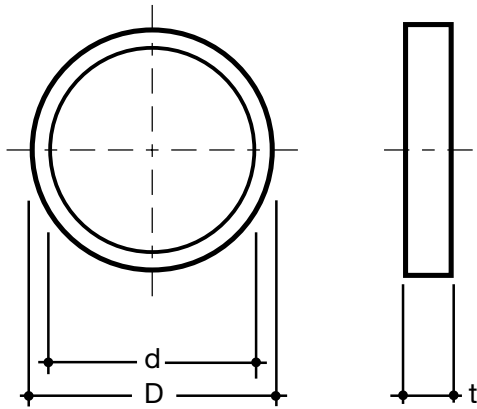

DIMENSIONS: millimeters (inches)

Type	D ±1.5	d ±1	t max.
VN32M00251K - -	32 (1.26)	28 (1.10)	2.8 (.110)
VN32M02750K - -	32 (1.26)	28 (1.10)	3.1 (.122)
VN32M00321K - -	32 (1.26)	28 (1.10)	3.7 (.146)
VN32M00381K - -	32 (1.26)	28 (1.10)	4.4 (.173)
VN32M00421K - -	32 (1.26)	28 (1.10)	4.9 (.193)
VN32M00461K - -	32 (1.26)	28 (1.10)	5.5 (.217)
VN32M00511K - -	32 (1.26)	28 (1.10)	6.0 (.236)
VN32M00750K - -	32 (1.26)	28 (1.10)	6.6 (.260)

HOW TO ORDER

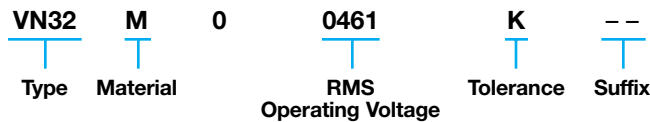

GENERAL CHARACTERISTICS

Max. operating temperature: +85°C
 Storage temperature: -40°C to +125°C
 Ceramic discs with silver layer on each face

MARKING

On packaging only

REMARK

Discs of 14 mm and 20 mm available upon request

PARTICULAR CHARACTERISTICS

Type	Max. operating voltage		Nominal voltage at 1 mA DC	Clamping voltage Vp(V)		Energy 1 surge (10 x 1000 µs) W (J)	Max. peak current with insulating coating (8 x 20 µs) Ip (kA)	
	V _{RMS} (V)	V _{DC} (V)	V _R (V)	at 2.5 kA	at 2.5 kA		1 pulse	2 pulses
VN32M00251K - -	250	330	390	970	1100	200	25	15
VN32M02750K - -	275	369	430	1075	1230	260	25	15
VN32M00321K - -	320	420	510	1200	1380	300	25	15
VN32M00381K - -	380	500	610	1350	1550	350	25	15
VN32M00421K - -	420	560	680	1500	1700	400	25	15
VN32M00461K - -	460	615	750	1650	1900	450	25	15
VN32M00511K - -	510	675	820	1800	2070	500	25	15
VN32M00750K - -	575	730	910	2000	2300	550	25	15

VOLTAGE-CURRENT CHARACTERISTICS

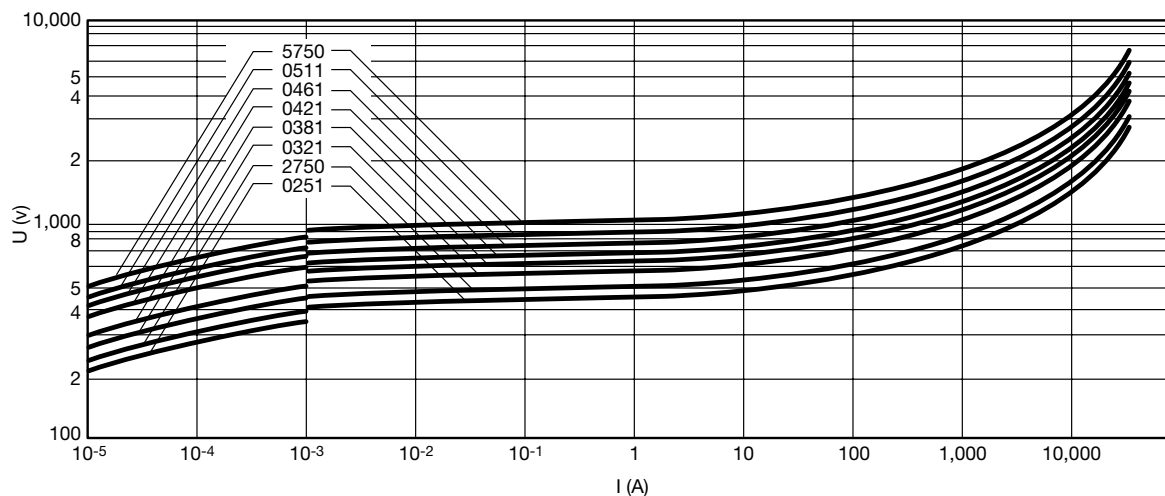

Zinc Oxide Varistors



VB 32 Blocks

DIMENSIONS millimeters (inches)

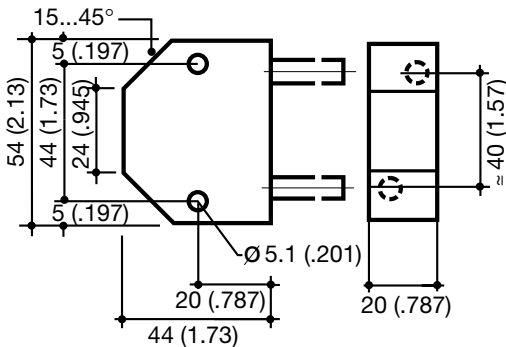

GENERAL CHARACTERISTICS

Max. operating temperature: +85°C
Storage temperature: -40°C to +85°C

MOUNTING

Ø 5 mm holes for screwing
500 mm long, 6 mm² insulated copper cables

PACKAGING

Bulk or three units per box (one for each phase)

HOW TO ORDER

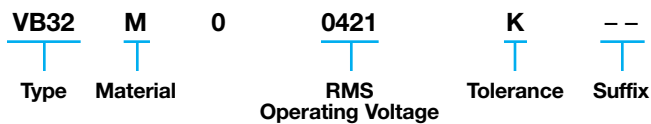

MARKING

Type
AC nominal voltage (EIA code)
Logo

PARTICULAR CHARACTERISTICS

Type	Max. operating voltage		Nominal voltage at 1 mA DC	Clamping voltage at 2.5 kA	Energy 1 surge (10 x 1000 µs)	Max. peak current with insulating coating (8 x 20 µs)	
	V _{RMS} (V)	V _{DC} (V)				V _R (V)	W (J)
VB32M00251K- -	250	330	390	970	200	25	15
VB32M02750K- -	275	369	430	1075	260	25	15
VB32M00321K- -	320	420	510	1200	300	25	15
VB32M00381K- -	380	500	610	1350	350	25	15
VB32M00421K- -	420	560	680	1500	400	25	15
VB32M00461K- -	460	615	750	1650	450	25	15
VB32M00511K- -	510	675	820	1800	500	25	15
VB32M00750K- -	575	730	910	2000	550	25	15

VOLTAGE-CURRENT CHARACTERISTICS

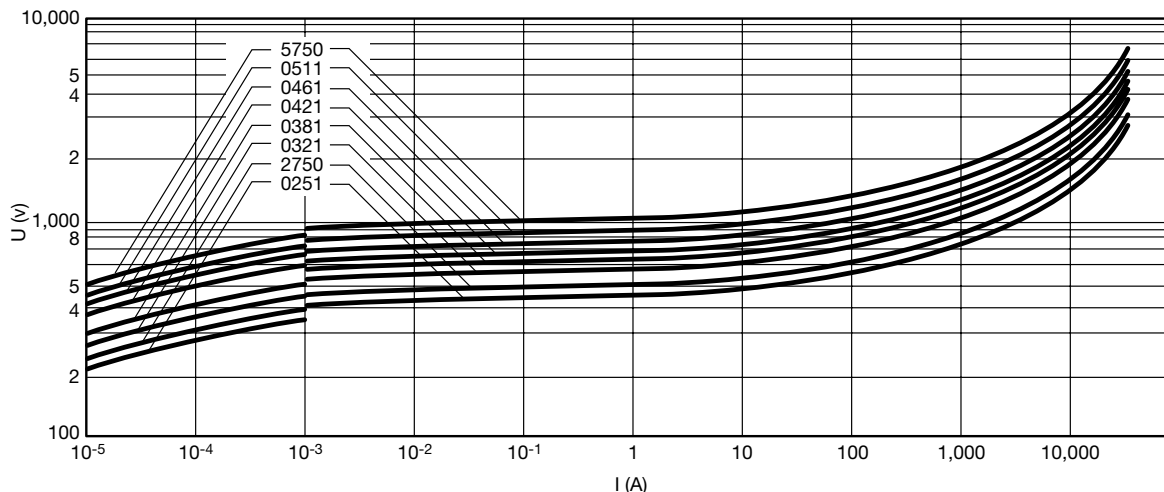

Zinc Oxide Varistors



Taping Characteristics

TAPING OF OUR VARISTORS IS MADE ACCORDING TO IEC 286-2

Types: VE07/09 - VF05/07

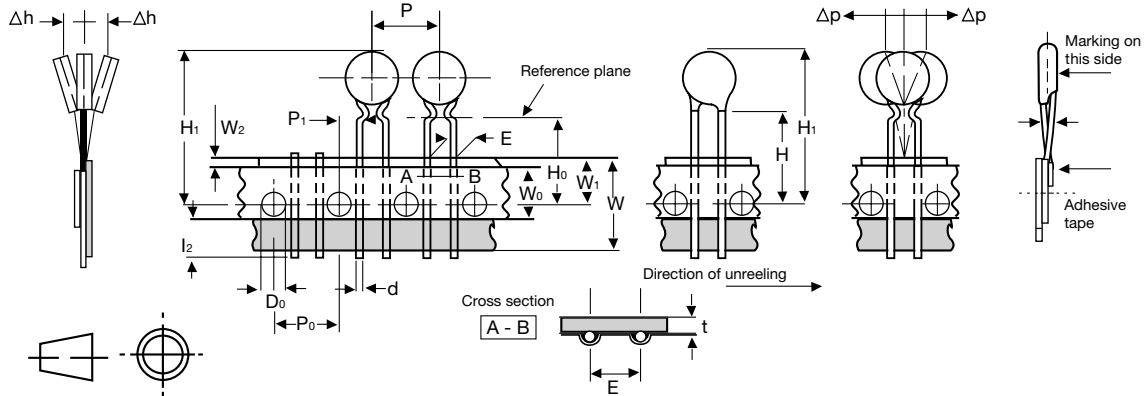

Types: VE13/17 - VF10/14

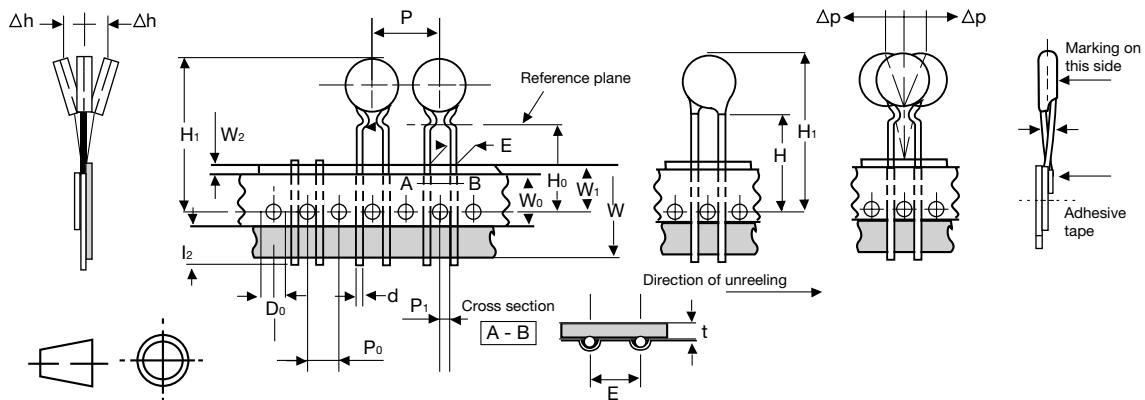

DIMENSIONS: millimeters (inches)

Dimension Characteristics	Value	Tolerance	
Leading tape width	18 (.709)	+1/-0.5	W
Adhesive tape width	The hold down tape shall not protrude beyond the carrier tape		W ₀
Sprocket hole position	9 (.354)	+0.75/-0.5	W ₁
Distance between the tops of the tape and the adhesive	3 (.118) max		W ₂
Diameter of sprocket hole	4 (.157)	±0.2	D ₀
Distance between the tape axis and the bottom plane of component body	16/ (.630)/ or 18 (.709)	±0.5/ -0/+2	H
Distance between the tape axis and the kink	16/ (.630)/ or 18 (.709)	±0.5/ -0/+2	H ₀
Distance between the tape axis and the top of component body VE 07/09 - VF 05/07 VE 13/17 - VF 10/14	33.0 (1.30) max 45.0 (1.77) max		H ₁
Lead diameter	0.6 (.024) 0.8 (.031)	+10% -0.05	d
Protrusions beyond the lower side of the hold down tape	5 (.197) max		l ₂
Lead spacing	5.08 (0.20) 7.62 (0.30)	±0.8	E
Components pitch	12.7 (0.50) 25.4 (0.10)	±0.3	p

DIMENSIONS: millimeters (inches)

Dimension Characteristics	Value	Tolerance	
Sprocket holes pitch	12.7 (0.50)	±0.3	P ₀
Distance between the sprocket hole axis and the lead axis	3.8 (.150)	±0.7	P ₁
Total thickness of tape	0.9 (.035) max		t
Verticality of components	0	±2	Δρ
Alignment of components	0	±2	Δh

Taping Characteristics

PACKAGING

For automatic insertion, the following types can be ordered on tape either in AMMOPACK (fan folder) or on REEL in accordance to IEC 286-2.

AMMOPACK

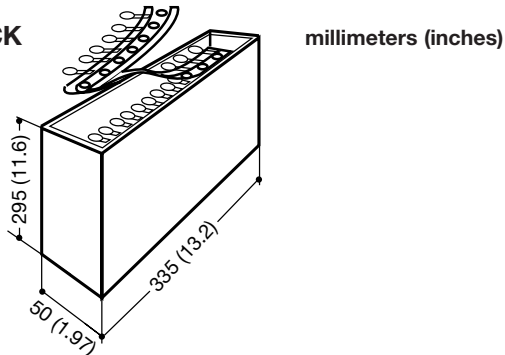

MISSING COMPONENTS

A maximum of 3 consecutive components may be missing from the bandolier, surrounded by at least 6 filled positions. The number of missing components may not exceed 0.5% of the total per packing module.

REEL

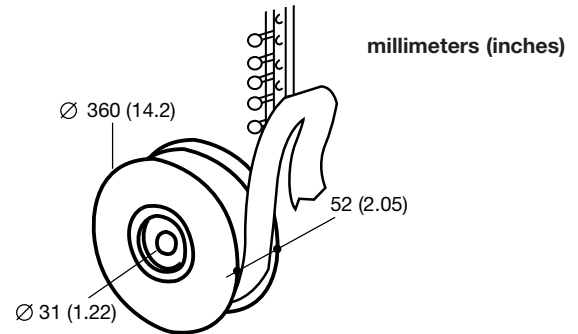

LEADS CONFIGURATION AND PACKAGING SUFFIXES

The tables below indicate the suffixes to be specified when ordering kink and packaging types. For devices on tape, it is necessary to specify the height (H or Ho) which is the distance between the tape axis (sprocket holes) and the sitting plane on the printed circuit board.

– Straight leads

H represents the distance between the sprocket holes axis and the bottom plane of component body (base of resin or base of stand off).

– Kinked leads

Ho represents the distance between the sprocket holes axis and the base of the knee.

Types	VE 07/09 - VF 05/07 (VE13 - VF10 320 V _{rms} upon request)					
Leads	Straight		Kinked (type 1)		Kinked (type 2)	
Dimensions						
Packaging	AMMOPACK	REEL	AMMOPACK	REEL	AMMOPACK	REEL
H/Ho = 16 ± 0.5	DA(*)	DB(*)	DQ(**)	DR(**)	D7(**)	D5(**)
H/Ho = 18 -0/+2	DC(**)	DD(**)	DS	DT	D8	D6

Types	VE 13/17 - VF 10/14					
Leads	Straight		Kinked (type 1)		Kinked (type 2)	
Dimensions						
Packaging	AMMOPACK	REEL	AMMOPACK	REEL	AMMOPACK	REEL
H/Ho = 16 ± 0.5	EA(*)	EN(*)	EC(**)	EF(**)	EQ(**)	ER(**)
H/Ho = 18 -0/+2	EB(**)	ED(**)	EG	EH	ES	ET

(*) DA, DB, EA, EN suffixes are not available for varistors with V_{RMS} 300V and available only upon request for other types.

(**) Preferred versions according to IEC 286-2



Zinc Oxide Varistors

Packaging

PACKAGING QUANTITIES

Type	Bulk	AMMOPACK	REEL
VE07 - VF05 all	1500	1500	1500
VE09 - VF07 < 230 V	1000	1500	1500
VE09 - VF07 230 V V _{RMS} 300 V	1000	1000	1000
VE09 - VF07 > 300 V _{RMS}	750	1000	1000
VE13 - VF10 230 V _{RMS}	500	750	750
VE13 - VF10 } > 230 V _{RMS}	500	500	500
VE13 - VF10 } > 300 V _{RMS}	500	—	—
VE13 - VF10 } > 300 V _{RMS}	500	—	—
VE17 - VF14 230 V _{RMS}	500	750	750
VE17 - VF14 } > 230 V _{RMS}	500	500	500
VE17 - VF14 } > 300 V _{RMS}	500	—	—
VE17 - VF14 } > 300 V _{RMS}	500	—	—
VE24 - VF20	250	—	—

IDENTIFICATION - TRACEABILITY

On the packaging of all shipped varistors, you will find a bar code label.

This label gives systematic information on the type of product, part number, lot number, manufacturing date and quantity.

An example is given below:

(H)Lot: **6B2960304407 /040** ← Lot number
960108 ← Manufacturing date (YYMMDD)
 (Q)Qty: **250** ← Quantity per packaging
 (2W)TPC-PN: **VE13M03850K --** ← Part number

This information allows complete traceability of the entire manufacturing process, from raw materials to final inspection.

This is extremely useful for any information request.

Quality

QUALITY SYSTEM

A high level of performance, quality and service has been achieved in setting up a quality system based on the ISO 9000 standard.

The system includes:

- A quality manual ensuring the proper organization
- Incoming inspection
- Manufacturing process control and final inspection as described on page 35
- Reliability tests according to IEC 68 and CECC 42000 standards as described on page 36
- Continuous improvement programs

APPROVALS

The quality of our products and organization has been recognized by the following approvals:

ISO 9002

Certificate of approval n° 928373

CECC, EN100114-1

Certificate of approval of manufacturer n° 004-96

CECC 42201-005

Qualification approval certificate N° 96-024
All VE/VF types

VDE

Certificate of approval n° 94763E
All VE/VF types with V_{RMS} from 25V to 575V

Underwriters Laboratories, Inc./Canadian Standards Association

- UL 1449 Transient Voltage Surge Suppressors
File E 84108 (S)
- UL 1414 - Across the line components
File 184 051
All types VE/VF with V_{RMS} from 130V to 275V

List GAM T1

Types VB1 (VE09) to VB4 (VE24)

List LNZ 44004

Types EPV-7A (VE09) to EPV-20A (VE24)

Zinc Oxide Varistors



Manufacturing Process and Quality Assurance



Reliability

PRODUCT QUALITY ASSURANCE

TPC has a Quality System that complies with the ISO & CECC quality requirements.

All products are tested and released by the quality department based on the compliance to established customer specifications. Critical raw materials are inspected for dimensional, electrical and physical properties prior to releasing to the production floor.

Routine checks are carried out at crucial processes. The finished products are submitted to Quality Control for inspection on electrical, dimensional, physical & visual conformance to relevant specifications, based on established AQLs.

The average outgoing quality level is < 10ppm on TPC varistors. The low ppm value is applicable for total functional failures, i.e. short circuit and open circuit.

RELIABILITY

TPC varistors are subjected to reliability tests stated in page 00 (per CECC 42000).

Life test is conducted to determine the life time of varistors. The test conditions used are stated in page 00. The varistors are subjected to these conditions for a minimum period of 1000 hours.

Failure in time (FIT) is computed for all tested parts based on Arrhenius equation. The definition of failure is a shift in the nominal voltage exceeding $\pm 10\%$. The FIT calculation is computed in units of $10^{-9}/h$.

Figures below give the FIT for low and high voltage varistors. The FIT values at various stresses are extrapolated based on Arrhenius equation.

FIT OF VARISTORS ($V_{rms} > 40 V$)

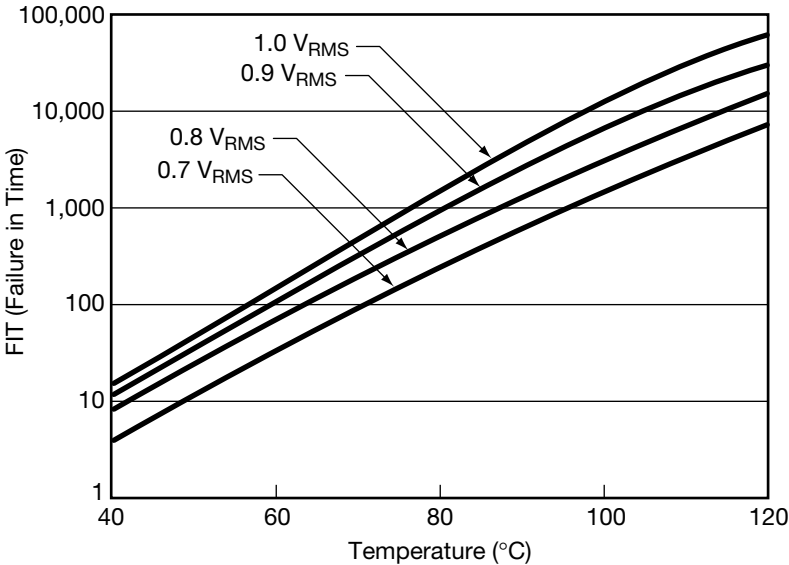

FIT OF VARISTORS ($V_{rms} \leq 40 V$)

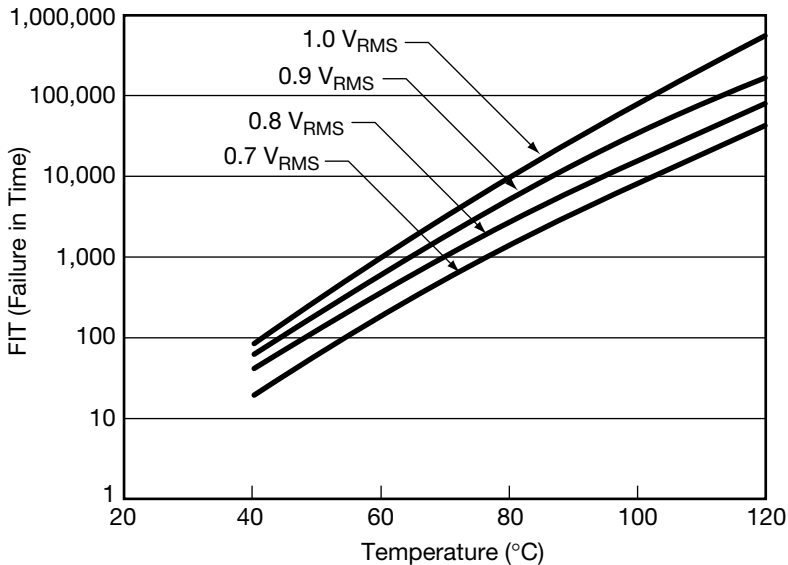

Reliability

Test Description	Test Condition	Test Requirement
SURGE CURRENT DERATING 8/20 MICRO SECONDS	CECC 42000, Test C 2.1 100 surge currents (8/20 μ s), unipolar, interval 30 s, amplitude corresponding to derating curve for 20 μ s.	<ul style="list-style-type: none"> • I Delta V/V (1 mA) I max 10% Measured in the direction of the surge current • No visible damage
SURGE CURRENT DERATING 10/1000 MICRO SECONDS	CECC 42000, Test C 2.1 100 surge currents (10/1000 μ s), unipolar, interval 120 s, amplitude corresponding to derating curve for 1000 μ s.	<ul style="list-style-type: none"> • I Delta V/V (1 mA) I max 10% Measured in the direction of the surge current • No visible damage
RESISTANCE TO SOLDERING HEAT	IEC 68-2-20, Test Tb Method 1A 260°C, 5 s	<ul style="list-style-type: none"> • I Delta V/V (1 mA) I max 5%
RAPID CHANGE IN TEMPERATURE	IEC 68-2-14, Test Na Ta = -40°C; Tb = +85°C Duration: 1 H Ω min/cycle Total: 5 cycles	<ul style="list-style-type: none"> • I Delta V/V (1 mA) I max 5% • No visible damage
SHOCK	IEC 68-2-27, Test Ea Pulse shape: half sine Acceleration: 490 m/s/s Pulse duration: 11 ms 3 x 6 shocks	<ul style="list-style-type: none"> • I Delta V/V (1 mA) I max 5% • No visible damage
VIBRATION	IEC 68-2-6, Test Fc Method B4 Freq. range: 10 Hz ... 55 Hz Amplitude: 0.75 mm or 98 m/s/s Duration: 6 h (3 x 2 h)	<ul style="list-style-type: none"> • I Delta V/V (1 mA) I max 5% • No visible damage
CLIMATIC SEQUENCE	CECC 42000, Test 4.16 a) Dry heat - Test Ba Temperature / Duration: 125°C / 2 h b) Damp heat cyclic 1st cycle - Test Db Temperature / Duration: 55°C / 24 h Humidity: 95-100% RH c) Cold - Test Aa Temperature / Duration: -40°C / 2 h d) Damp heat cyclic test remaining 5 humidity cycles - Test Db Duration: 24 h/cycle	<ul style="list-style-type: none"> • I Delta V/V (1 mA) I max 10% • Insulation Resistance min 1 Mohm
LIFE TEST	CECC 42000, Test 4.20 Applied voltage: max continuous a.c. Voltage, continuous application Temperature / Duration: 85°C / 1000 h	<ul style="list-style-type: none"> • I Delta V/V (1 mA) I max 10% • Insulation Resistance min 10 Mohm
DAMP HEAT, STEADY STATE	IEC 68-2-3 Temperature / Duration: 40°C / 56 days Humidity: 93%	<ul style="list-style-type: none"> • I Delta V/V (1 mA) I max 10% • Insulation Resistance min 1 Mohm
FLAMMABILITY - NEEDLE FLAME TEST	IEC 695-2-2 Vertical application: 10 s	<ul style="list-style-type: none"> • Burning max 10 s
TEMPERATURE COEFFICIENT OF VOLTAGE	Current: 1 mA Temperature: -40°C / +25°C / +85°C	<ul style="list-style-type: none"> • - (0.09%/K) max

USA

AVX Myrtle Beach, SC Corporate Offices

Tel: 843-448-9411
FAX: 843-448-1943

AVX Northwest, WA

Tel: 360-669-8746
FAX: 360-699-8751

AVX North Central, IN

Tel: 317-848-7153
FAX: 317-844-9314

AVX Northeast, MA

Tel: 508-485-8114
FAX: 508-485-8471

AVX Mid-Pacific, CA

Tel: 408-436-5400
FAX: 408-437-1500

AVX Southwest, AZ

Tel: 602-539-1496
FAX: 602-539-1501

AVX South Central, TX

Tel: 972-669-1223
FAX: 972-669-2090

AVX Southeast, NC

Tel: 919-878-6357
FAX: 919-878-6462

AVX Canada

Tel: 905-564-8959
FAX: 905-564-9728

EUROPE

AVX Limited, England European Headquarters

Tel: ++44 (0)1252 770000
FAX: ++44 (0)1252 770001

AVX S.A., France

Tel: ++33 (1) 69.18.46.00
FAX: ++33 (1) 69.28.73.87

AVX GmbH, Germany - AVX

Tel: ++49 (0) 8131 9004-0
FAX: ++49 (0) 8131 9004-44

AVX GmbH, Germany - Elco

Tel: ++49 (0) 2741 2990
FAX: ++49 (0) 2741 299133

AVX srl, Italy

Tel: ++39 (0)2 665 00116
FAX: ++39 (0)2 614 2576

AVX sro, Czech Republic

Tel: ++420 (0)467 558340
FAX: ++420 (0)467 2844

ASIA-PACIFIC

AVX/Kyocera, Singapore Asia-Pacific Headquarters

Tel: (65) 258-2833
FAX: (65) 350-4880

AVX/Kyocera, Hong Kong

Tel: (852) 2-363-3303
FAX: (852) 2-765-8185

AVX/Kyocera, Korea

Tel: (82) 2-785-6504
FAX: (82) 2-784-5411

AVX/Kyocera, Taiwan

Tel: (886) 2-2516-7010
FAX: (886) 2-2506-9774

AVX/Kyocera, China

Tel: (86) 21-6249-0314-16
FAX: (86) 21-6249-0313

AVX/Kyocera, Malaysia

Tel: (60) 4-228-1190
FAX: (60) 4-228-1196

Elco, Japan

Tel: 045-943-2906
FAX: 045-943-2910

Kyocera, Japan

Tel: (81) 75-593-4518
FAX: (81) 75-502-2705

Contact:



Mouser Electronics

Authorized Distributor

Click to View Pricing, Inventory, Delivery & Lifecycle Information:

AVX:

[VE07M00151K](#) [VE09M00250KD5](#) [VE07M00300K--](#) [VE24M00211K--](#) [VE09M00151KDD](#) [VE09M00151K--](#)
[VE17M02750KED](#) [VE09M00480K--](#) [VE24P00151K--](#) [VE13P01750K--](#) [VE17P01750K--](#) [VE09P01750K--](#)
[VE07P01750K--](#) [VE13P00151K--](#) [VE17P00151K--](#) [VE24P00231K--](#) [VE24P01750K--](#) [VE24P00131K--](#)
[VE24P00251K--](#) [VE09P00251K--](#) [VE07P00251K--](#) [VE17P00211K--](#) [VE13P00211K--](#) [VE09P00131K--](#)
[VE24P00211K--](#) [VE13P00131K--](#) [VE17P00131K--](#) [VE13P00251K--](#) [VE07P00211K--](#) [VE17P00251K--](#)
[VE09P00211K--](#) [VE13P00141K--](#) [VE07P00141K--](#) [VE07P00151K--](#) [VE09P00151K--](#) [VE09M00301KDD](#)
[VE09M00300KDD](#) [VE09M00600K](#) [VE13M00301K--](#) [VE09M02750KDD](#) [VE17M00321KEF](#) [VE09M00250KDC](#)
[VE13P00321K--](#) [VE07M00251K](#) [VE13P00301K--](#) [VE17P00301K--](#) [VE24P00301K--](#) [VE07P00301K--](#) [VE17P02750K-](#)
[-](#) [VE13P02750K--](#) [VE24P02750K--](#) [VE09P02750K--](#) [VE07P02750K--](#) [VE17M02750K--](#) [VE09M00750K--](#)
[VE24M00131K--](#) [VE09M00251K--](#) [VE09M00400K--](#) [VE13M00400K--](#) [VE17M00600K--](#) [VE09M00141K](#)
[VE09M00131K](#) [VE09M00151K-](#) [VE17M00251K--](#) [VE24M00131K-](#) [VE17M02750K-](#) [VE09M00750K-](#) [VE24M00151K--](#)
[VE17M00151K--](#) [VE09M00251K-](#) [VE24M00511K--](#) [VE17M00131K--](#) [VE07M00131K--](#) [VE07M00131KDD](#)
[VE07M00140K--](#) [VE07M00140KDB](#) [VE07M00140KDD](#) [VE07M00141K--](#) [VE07M00151KDD](#) [VE07M00170K--](#)
[VE07M00200K--](#) [VE07M00211K--](#) [VE07M00231K--](#) [VE07M00250K--](#) [VE07M00250KDR](#) [VE07M00251KDD](#)
[VE07M00300KDB](#) [VE07M00301K--](#) [VE07M00350K--](#) [VE07M00400K--](#) [VE07M00500K--](#) [VE07M01150K--](#)
[VE07M01750K--](#) [VE07M02750K--](#) [VE07P00131K--](#) [VE07P00231K--](#) [VE07P00251KDB](#) [VE07P02750KDD](#)
[VE09M00131K--](#) [VE09M00131KDD](#)